



IC25 ION CHROMATOGRAPH OPERATOR'S MANUAL

© 2000 Dionex Corporation

Document No. 031685
Revision 01
April 2000

©2000 by Dionex Corporation
All rights reserved worldwide.
Printed in the United States of America.

This publication is protected by federal copyright law. No part of this publication may be copied or distributed, transmitted, transcribed, stored in a retrieval system, or transmitted into any human or computer language, in any form or by any means, electronic, mechanical, magnetic, manual, or otherwise, or disclosed to third parties without the express written permission of Dionex Corporation, 1228 Titan Way, Sunnyvale, California 94088-3603 U.S.A.

DISCLAIMER OF WARRANTY AND LIMITED WARRANTY

THIS PUBLICATION IS PROVIDED “AS IS” WITHOUT WARRANTY OF ANY KIND. DIONEX CORPORATION DOES NOT WARRANT, GUARANTEE, OR MAKE ANY EXPRESS OR IMPLIED REPRESENTATIONS REGARDING THE USE, OR THE RESULTS OF THE USE, OF THIS PUBLICATION IN TERMS OF CORRECTNESS, ACCURACY, RELIABILITY, CURRENTNESS, OR OTHERWISE. FURTHER, DIONEX CORPORATION RESERVES THE RIGHT TO REVISE THIS PUBLICATION AND TO MAKE CHANGES FROM TIME TO TIME IN THE CONTENT HEREINOF WITHOUT OBLIGATION OF DIONEX CORPORATION TO NOTIFY ANY PERSON OR ORGANIZATION OF SUCH REVISION OR CHANGES.

TRADEMARKS

SRS® and Self-Regenerating Suppressor® are registered trademarks and DX-LAN™ is a trademark of Dionex Corp.

PRINTING HISTORY

Revision 01, April 2000

1 • Introduction

1.1	Overview	1-1
1.2	About This Manual	1-2
1.2.1	Typefaces	1-3
1.2.2	Safety Messages and Notes	1-3
1.3	Safety Labels	1-4

2 • Description

2.1	Front Control Panel	2-1
2.1.1	Control Panel Keypad	2-2
2.1.2	Initial Display Screens	2-5
2.2	Electronics Chassis	2-6
2.2.1	Connectors	2-7
2.2.2	Cards	2-8
2.3	Mechanical Chassis	2-10
2.4	Interior Components	2-10
2.4.1	Pump Heads	2-10
2.4.2	Pump Priming Block	2-12
2.4.3	Pressure Transducer	2-12
2.5	Conductivity Cell	2-13
2.6	Vacuum Degas Pump Assembly (Optional)	2-14

2.7 Eluent Reservoirs2-15

2.8 Rear Panel2-15

2.9 Functional Description2-16

 2.9.1 Operating and Control Modes2-16

 2.9.2 Operating Modes2-17

 2.9.3 Method Control2-17

3 • Operation and Maintenance

3.1 Getting Ready to Run3-1

 3.1.1 Degas Eluents3-1

 3.1.2 Filter Eluents3-2

 3.1.3 Pressurize Eluent Reservoirs3-2

 3.1.4 Start-Up3-3

 3.1.5 Selecting the Pressure Limits3-4

3.2 Running Under Direct Control (Local Mode)3-5

3.3 Running Under Method Control (Local Mode)3-6

 3.3.1 Creating a New Method3-7

 3.3.2 Running a Method3-9

 3.3.3 Controlling the Method Clock3-9

 3.3.4 Editing a Method3-10

 3.3.5 Deleting a Method3-11

 3.3.6 Changing the Running Method3-11

3.4 Optimizing Temperature Compensation3-11

3.5 Shutdown3-12

3.6 Routine Maintenance3-12

3.6.1 Daily Maintenance3-12

3.6.2 Periodic Maintenance3-14

4 • Troubleshooting

4.1 Left-Right Pump Head Pressure Fluctuations4-1

4.2 Pump Will Not Start4-3

4.3 Pump Stops4-3

4.4 Liquid Leaks/Leak Alarm4-7

4.5 High-Pitched Noise From Pump Motor (or Motor Racing)4-8

4.6 Vacuum Degas Pump Does Not Run4-9

4.7 Vacuum Degas Pump Calibration Fails4-10

4.8 Vacuum Degas Pump Low Vacuum4-11

4.9 Inoperative Relay Control Function4-11

4.10 Poor Chromatographic Reproducibility4-12

4.11 No Detector Response4-12

4.12 Low Detector Output4-13

4.13 High Detector Output4-13

4.14 Noisy or Drifting Baseline4-13

4.15 Conductivity Inaccurate4-14

4.16 Faulty DX-LAN Communication4-15

5 • Service

5.1	Changing Main Power Fuses	5-2
5.2	Cleaning and Replacing the Check Valves	5-3
5.3	Piston Seal Replacement	5-5
5.4	Pump Piston Replacement	5-9
5.5	Pressure Transducer Waste Valve O-Ring Replacement	5-10
5.6	Eliminating Liquid Leaks	5-11
5.7	Removing Trapped Air from the Cell	5-11
5.8	Calibrating the Cell	5-12

A • Specifications

A.1	Physical	A-1
A.2	Environmental	A-1
A.3	Electrical	A-1
A.4	Hydraulics	A-2
A.5	Conductivity Detector	A-2
A.6	Conductivity Cell	A-2
A.7	SRS Power Supply	A-3
A.8	Vacuum Degas Assembly (Optional)	A-3
A.9	Display and Keypad	A-3
A.10	Method Control	A-3

B • Installation

B.1	Facility Requirements	B-1
B.2	Rear Panel Connections	B-2
B.2.1	Power Connection	B-2
B.2.2	Waste Lines	B-3
B.2.3	DX-LAN Interface: 10BASE-T Connections (Optional)	B-4
B.2.4	DX-LAN Interface: BNC Connections (Optional)	B-7
B.3	Electronics Chassis Connections	B-10
B.4	Eluent Reservoir Connections	B-11
B.4.1	Eluent Inlet Line Connection	B-11
B.4.2	Eluent Outlet Line Connection	B-11
B.5	Priming the Pump	B-12
B.5.1	Priming Using the Priming Block	B-12
B.5.2	Priming Using the Prime Button	B-14
B.5.3	Priming the Pump Heads with Isopropyl Alcohol.	B-15
B.6	Automatic SRS Power Control (Optional)	B-16

C • User Interface

C.1	Operational Screens	C-3
C.1.1	Main Screen	C-3
C.1.2	Detail Screen	C-5
C.1.3	Method Screen	C-7
C.1.4	Module Setup	C-9
C.1.5	Pump Options	C-10

C.1.6	Time Function In	C-11
C.1.7	Degas Options	C-12
C.1.8	Analog Out Setup	C-14
C.2	Diagnostic Screens	C-15
C.2.1	Diagnostic Menu	C-15
C.2.2	Power-Up Screen	C-16
C.2.3	Elapsed Time	C-17
C.2.4	DSP Status	C-18
C.2.5	Keyboard Test	C-19
C.2.6	Signal Statistics	C-20
C.2.7	Diagnostic Test.	C-21
C.2.8	Pressure Statistics	C-22
C.3	Calibration Screens	C-23
C.3.1	Calibration Menu	C-23
C.3.2	Calibration Status	C-24
C.3.3	Leak Sensor Calibration and Status	C-25
C.3.4	Degas Pump Calibration.	C-26
C.3.5	Flow Calibration.	C-27
C.3.6	Pressure Calibration	C-28
C.3.7	Calibrate Conductivity Cell	C-32

D • TTL and Relay Control

D.1	TTL and Relay Output Operation	D-2
D.2	TTL Input Operation	D-3

D.2.1	Input Function Assignments	D-4
D.2.2	TTL Input Signal Modes	D-4
D.3	TTL and Relay Connections	D-6
D.3.1	Example Connections	D-7

E • Reordering Information

Index

1.1 Overview

The IC25 Ion Chromatograph performs isocratic ion analyses using conductivity detection. The IC25 integrates pump and detector functions in a single instrument. The microprocessor-based, dual-piston, variable-speed, delivery system pumps eluents at precisely controlled flow rates. The IC25 electronics provide sensitive, accurate detection and quantification of ionic analytes in liquid and ion chromatography. This is especially useful for analytes that lack UV chromophores and cannot be determined with adequate sensitivity by UV absorbance. A Digital Signal Processor (DSP) provides high speed control of pump flow and pressure.

The IC25 can operate with non-Dionex modules that meet the IC25 interface requirements for software, TTL, or relay control.

The IC25 can be controlled locally, from the front panel, or remotely (via the Dionex DX-LAN™ interface), from a host computer running PeakNet 6, Release 6.1 (or later) software. Limited remote control is also available using TTL signals.

The IC25 is available in three versions (all plumbed with PEEK tubing):

- P/N 056589 includes a single-chamber vacuum degas pump.
- P/N 056590 includes a double-chamber vacuum degas pump, as well as an eluent selection valve that allows switching between two eluents.
- The standard IC25 (P/N 051591) does not include a vacuum degas pump or eluent selection valve.

The two basic modes of IC25 control, Method control and Direct control, enable it to operate with or without reference to time-based events.

For applications requiring a controlled above-ambient temperature environment for the chromatography components (the analytical column, detector cell, etc.), Dionex recommends operating the IC25 with an LC25 Chromatography Oven. The LC25 operates over a range of 30 to 45 °C (86 to 113 °F), settable in one-degree increments. The temperature is selected from the IC25 front panel.

1.2 About This Manual

Chapter 1, Introduction	Introduces the IC25 and explains the conventions used in the manual, including safety-related information.
Chapter 2, Description	Describes the IC25 operating features, the control modes, and the chromatographic fluid path.
Chapter 3, Operation and Maintenance	Provides procedures for operation and routine preventive maintenance.
Chapter 4, Troubleshooting	Lists problems, with step-by-step procedures to isolate and eliminate their sources.
Chapter 5, Service	Provides step-by-step instructions for routine service and parts replacement procedures.
Appendix A, Specifications	Lists the IC25 specifications and installation site requirements.
Appendix B, Installation	Describes how to install the IC25.
Appendix C, User Interface	Illustrates and describes the front panel operating and diagnostic screens.
Appendix D, Relay and TTL Control	Describes the relay and TTL input and output functions and provides setup examples.
Appendix E, Reordering Information	Lists spare parts for the IC25.

1.2.1 Typefaces

- Capitalized bold type indicates a front panel button:
Press **Enter** to begin running the method.
- Uppercase bold type indicates the name of a screen, the name of a menu, or an on-screen entry:
Go to the **METHOD** screen.
Move the cursor to the **EDIT** field.

1.2.2 Safety Messages and Notes

This manual contains warnings and precautionary statements that can prevent personal injury and/or damage to the instrument when properly followed. Safety messages appear in bold type and are accompanied by icons.



Indicates an imminently hazardous situation which, if not avoided, will result in death or serious injury.



Indicates a potentially hazardous situation which, if not avoided, could result in death or serious injury.



Indicates a potentially hazardous situation which, if not avoided, may result in minor or moderate injury.



Indicates that the function or process of the instrument may be impaired. Operation does not constitute a hazard.

Informational messages also appear throughout this manual. These are labeled NOTE and are in bold type:

NOTE NOTES call attention to certain information. They alert you to an unexpected result of an action, suggest how to optimize instrument performance, etc.

1.3 Safety Labels

The CE and GS safety label on the IC25 attests to compliance with the following European, EMC, and safety requirements: Council Directives 73/23/EEC and 89/336/EEC, EN 61010-1:1993 (safety), EN 50082-1:1992 (susceptibility), and EN 55011:1991 (emissions).

The symbols below appear on the IC25, or on IC25 labels.



Alternating current



Protective conductor terminal



Power supply is on



Power supply is off

2.1 Front Control Panel

The control panel on the upper door of the IC25 contains the liquid crystal display (LCD), the membrane keypad, and the actuator for the main power switch (see Figure 2-1). The door opens to provide access to the electronics chassis, described in Section 2.2.

Screen Contrast

Information is displayed on the LCD, also called the *screen*. To adjust the screen contrast, use the knurled knob in the recess below the keypad (see Figure 2-1).

Power Switches

The main power switch is on the bulkhead behind the upper door. An actuator for the main power switch is on the outside of the front door, at the lower left corner. The actuator functions only when the door is fully closed.

When the door is open, press the main power switch on the bulkhead, instead of the actuator, to turn the module off and on.



To prevent damage to the IC25 circuitry and components, always wait at least 15 seconds after powering down before turning on the power again.

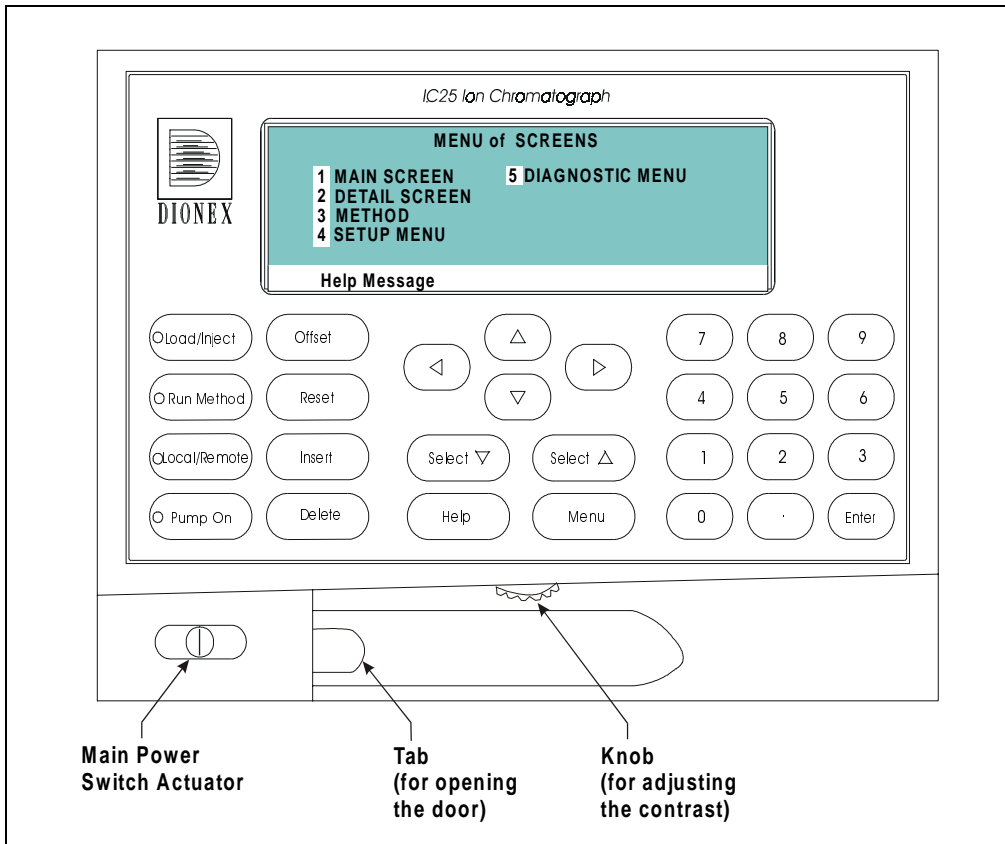

Figure 2-1. IC25 Display and Keypad Layout

2.1.1 Control Panel Keypad

Use the keypad to directly control IC25 operation, as well as to create and modify programmed series of timed events, called *methods*. In summary:

- Press **Menu** to display a list of available screens.
- In the screens, only fields shown in reverse video can be edited. Other fields only display information.
- To edit a field, use the four directional arrow buttons to position the cursor in the reverse video fields. Use the numeric buttons to enter variable values.

- Use the **Select** ▾ and **Select** △ buttons to choose between predetermined options. Pressing a **Select** button increases (or decreases) a numeric value by one; holding down a **Select** button increases (or decreases) a numeric value continuously.
- Press **Enter** or a cursor arrow button to execute the selected value.

A high-pitched beep sounds when a button is pressed. When an error occurs, this beep is lower in frequency. The beeps can be disabled from the **MODULE SETUP** screen (see Section C.1.4).

Button	Function
Load/Inject	Switches the position of the injection valve between Load and Inject.
Run Method	Turns the method clock on and off. This button functions only when the IC25 is in Method control.
Local/Remote	Switches from Local to Remote operation.
Pump On	Turns the pump on and off.
Offset	Returns the analog (recorder) output to a predetermined baseline and zeros the display. The resultant value of the offset required is displayed on the DETAIL screen. This function can be programmed in a method.
Reset	Changes the method clock time to INIT and causes the initial conditions specified by the method to occur. This button functions only when the IC25 is in Method control.
Insert	<p>Inserts a new timed step into a method. This button functions only when the cursor is in a TIME field on the METHOD or METHOD extension screen.</p> <ol style="list-style-type: none"> 1. Move the cursor to the TIME field and press Insert. This adds a new step after the cursor position. Parameter values in the new step will be blank. 2. Fill in the time value and press Enter or a cursor arrow button. (If the cursor is moved to a different field before a time value is entered, the inserted step disappears.) Continue inserting timed steps in any order; they will automatically be organized chronologically.

Table 2-1. Control Panel Button Functions

Button	Function
Delete	Removes the value from the current entry field, allowing entry of a new value. To restore the previous value, move the cursor from the field before entering the new value.
	Moves the cursor, in the direction of the arrow, to the next entry field. When there is no changeable field in that direction, the cursor moves diagonally or remains where it is.
Select ∇ Select Δ	<p>When the cursor is in a field with predetermined parameters, these buttons cycle through the choices. In fields with predetermined numeric values, Select Δ increases the value by one unit and Select ∇ decreases the value by one unit.</p> <p>Holding down a Select button increases (or decreases) the value continuously. To execute the new value, press Enter or a cursor arrow button.</p>
Help	Displays a Help screen pertaining to the current entry field.
Menu	<p>Displays one of three menus, depending on the current screen:</p> <ul style="list-style-type: none"> • From an operational or setup screen, pressing Menu displays the MENU of SCREENS. • From a diagnostic screen, pressing Menu once displays the DIAGNOSTIC MENU. Pressing Menu again redisplay the MENU of SCREENS. • From a calibration screen, pressing Menu once displays the CALIBRATION MENU. Pressing Menu again redisplay the DIAGNOSTIC MENU and then the MENU of SCREENS. <p>See Figure C-1 for an overview of the menu structure.</p>
Numeric Buttons	<p>Enters 0 through 9 and a decimal into the current entry field.</p> <p>From a menu screen, pressing a numeric button opens the corresponding screen.</p>
Enter	<p>Saves and/or executes changes made in entry fields. After pressing Enter, the cursor returns to the left margin of the field.</p> <p>On menu screens, pressing Enter opens the highlighted screen.</p> <p>On the METHOD screen, pressing Enter saves entries to an edit copy only. To save editing changes to a permanent method, move the cursor to the SAVE TO field, enter a method number, and press Enter.</p>

Table 2-1. Control Panel Button Functions (Continued)

To access other screens, press the **Menu** button on the front panel to display the **MENU of SCREENS** (see Figure 2-4). To select an option, move the cursor to a screen name and press **Enter**, or enter the screen number on the keypad and press **Enter**. See Appendix C for a description of each screen.

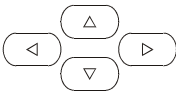
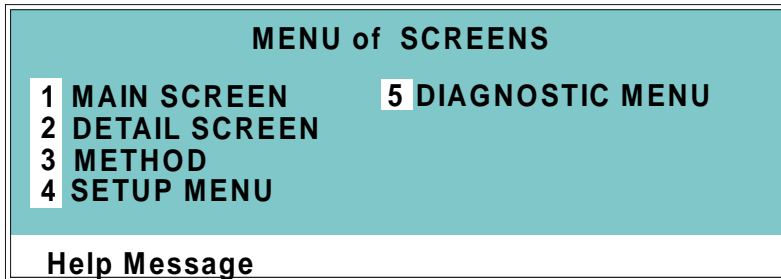

Figure 2-4. Menu of Screens

2.2 Electronics Chassis

The electronics chassis is located behind the upper door of the IC25 enclosure. The chassis includes several electronics cards (printed circuit boards) required for IC25 control. Connectors on the cards also enable the IC25 to communicate with other modules or accessories in the system. Figure 2-5 shows the electronics components with the upper door open. To open the door, pull on the tab beside the main power actuator (see Figure 2-1).



Do not remove any of the electronics cards from the IC25. There are no user-serviceable components on the cards. If servicing is required, it must be performed by qualified personnel and appropriate electrostatic discharge (ESD) handling procedures must be followed.

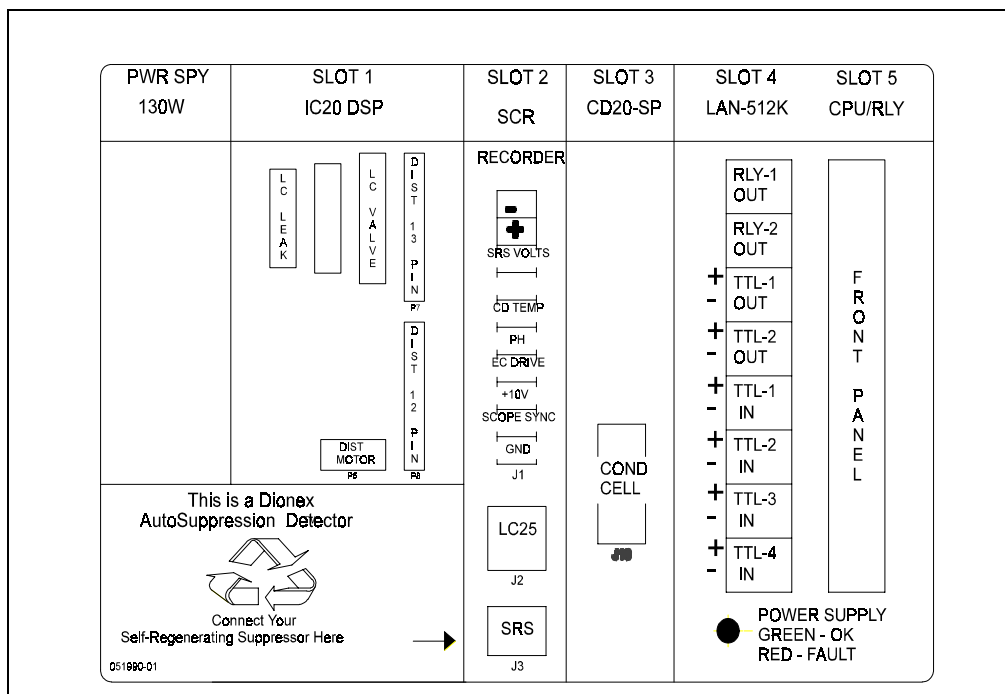

Figure 2-5. IC25 Electronics Chassis
(Located behind system door)

2.2.1 Connectors

LC VALVE

The cable from the Rheodyne injection valve in the LC25 Chromatography Oven (if installed) connects to the **LC VALVE** connector in slot 1.

TTL/Relay

A strip of eight relay and TTL connectors is located in slot 5. These connectors interface with other devices (Dionex or non-Dionex). Appendix D describes the relay and TTL functions, as well as the connections between the IC25 and other devices.

2.2.2 Cards

Power Supply Module

Provides power for the IC25 electronics.

DSP (Digital Signal Processor) Card

Contains the digital circuitry to interface to the CPU.

SCR (Supply Control/Relay) Card

Interfaces to the CPU. The SCR card contains three functions:

- 16-bit Recorder Output Digital-to-Analog Converter—Includes an electronic switch for selection of full-scale outputs of 0.01, 0.1, and 1.0 V.
- SRS[®] Power Supply—Supplies a regulated current (set by the user) of 50, 100, 300, or 500 mA to the Self-Regenerating Suppressor[®]. An over-voltage detector shuts off the power if the voltage exceeds 8.5 V. An over-temperature detector shuts off the power if the SRS temperature exceeds 40 °C. If one of these situations occurs, the SCR card sends an “SRS Alarm” error message to the CPU.
- LC25 Power Supply—Supplies heating power to the LC25 Chromatography Oven. While warming or cooling to a lower set point, a “BELOW TEMP” or “ABOVE TEMP” message is displayed. Once the set point is reached, proportional heat control maintains a constant temperature.

SP Card

Contains digital circuitry for the interface to the CPU, as well as the analog circuitry required for the IC25. The Signal Processor (SP) card contains the following functions:

- Temperature compensation digital-to-analog converter
- Cell chopper, driver
- Offset digital-to-analog scaling switch
- Conductivity signal receiver
- Second-stage amplifier and gain switch

- Synchronous rectifier
- 5 ms noise filter
- DC amplifier 100 ms filter
- Signal selection (MUX)
- 16-bit analog-to-digital converter
- Digital interface

CPU/Relay and DX-LAN Cards

The CPU logic and Relay I/O cards occupy slot 5 in the card cage. The Relay I/O card rides piggyback on the CPU card, extending over the front of slot 4. The card is short enough to allow a DX-LAN interface card to be mounted behind it in slot 4.

The DX-LAN interface card is required for communication between the IC25 and PeakNet 6 software. See Appendix B for card installation instructions.

Control Moduleware and BIOS for the IC25 reside on the CPU card. A 60-pin ribbon cable links the CPU logic to the IC25 front panel display and keypad.

The CPU logic monitors the internal power supply outputs and reports the status on the multicolored LED at the bottom of slot 4.

- Green indicates normal operation.
- Red indicates a power fault. When a power fault occurs, the IC25 enters its diagnostic state and all other controls are inhibited until the fault is corrected. Turn off the power to the IC25 for a few seconds and then turn it on again. If the power fault remains, contact Dionex.

2.3 Mechanical Chassis

The mechanical chassis is housed in the pull-out drawer located behind the lower door of the IC25 enclosure. The front of the chassis contains the components described in Section 2.4. Other mechanical assemblies are located inside the chassis drawer.

Pull out the drawer only for service procedures. Before resuming routine operation, push in the drawer and tighten the lock on the lower right corner of the chassis.



CAUTION

Observe the warning label on the inside of the lower door. Arrows on the label indicate moving mechanical parts that present pinch hazards when the IC25 power is on and the mechanical drawer is open. Never operate the IC25 with the mechanical chassis drawer open.

2.4 Interior Components

Figure 2-6 shows the interior components located behind the lower door of the IC25 enclosure. Figure 2-7 illustrates the eluent flow path through the pump.

The vacuum degas chamber and eluent selection valve shown in these drawings are not present in all versions of the IC25.

2.4.1 Pump Heads

Figure 5-1 illustrates the pump heads and interconnecting lines. The table below summarizes the pump head features and operating conditions.

Piston Volume	Flow Rate (mL/min)	Maximum Operating Pressure
100 μ L	0.04 –10.0	35 MPa (5000 psi)

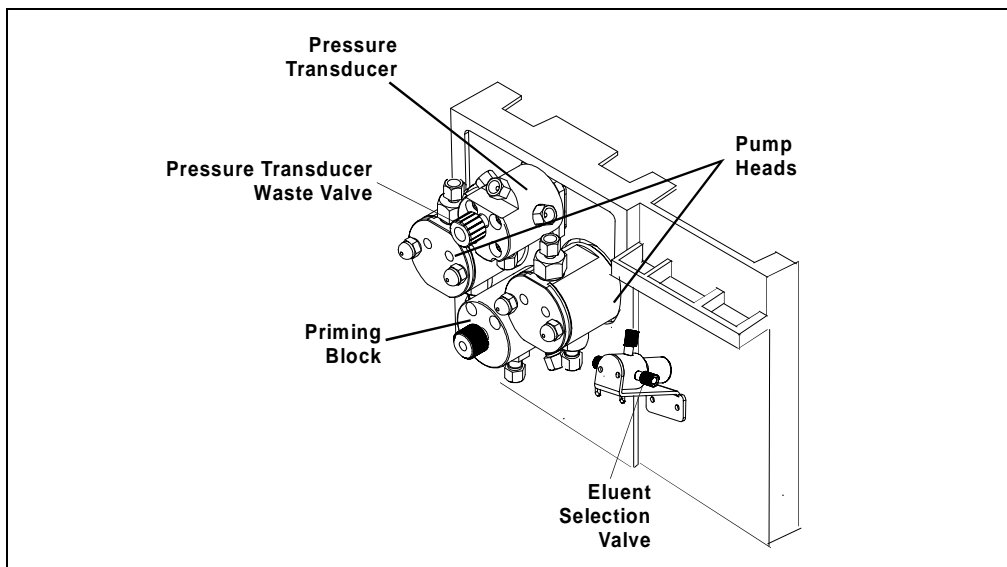

Figure 2-6. Pump Mechanical Components

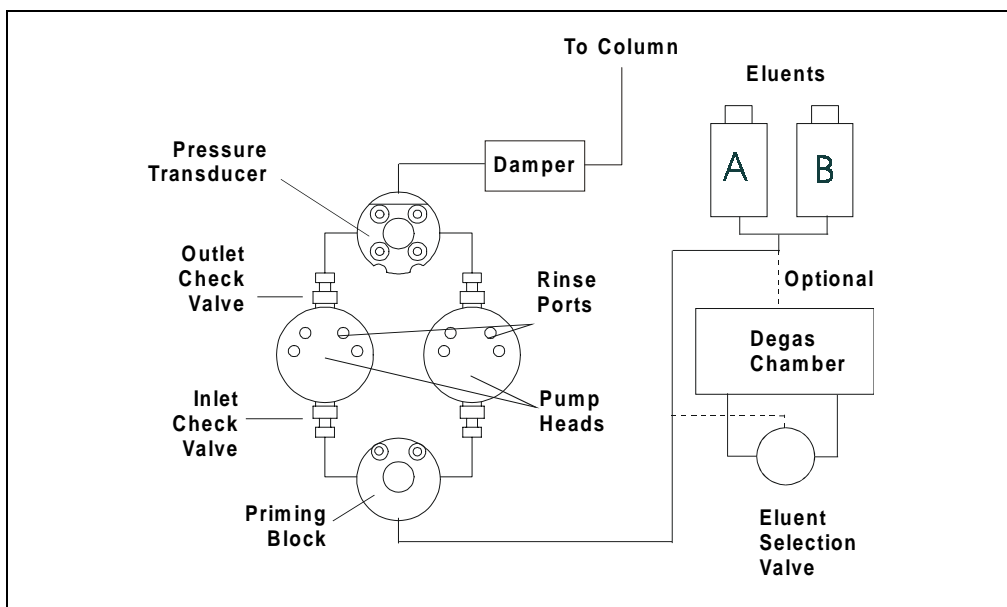

Figure 2-7. Eluent Flow Schematic

2.4.2 Pump Priming Block

The priming block “tee” directs eluent flow from the eluent selection valve into the pump heads. The priming block is also used to quickly remove air from the system.

See Section B.5 for instructions on priming the pump heads.

2.4.3 Pressure Transducer

From the priming block, the liquid stream is directed to the inlet check valves on the pump heads, through the pump heads, and through the outlet check valves to the pressure transducer.

Flow paths from the outlet check valves on the pump heads are combined in the pressure transducer. The pressure transducer measures the system pressure at this point. The interactive constant-flow/constant-pressure control program on the DSP precisely controls the pump motor speed to assure flow rate accuracy.

A waste line exits the bottom of the pressure transducer. Opening the knob on the pressure transducer diverts flow to the waste line. Opening the valve relieves system pressure and forces air out of the system.

Flow output from the pressure transducer is directed through the damper assembly and then out of the IC25 to the rest of the chromatography system (injection valve, column, detector).

2.5 Conductivity Cell

The flow-through conductivity cell has an active volume of about 1.0 μ L. Two 316 stainless steel electrodes are permanently sealed into the PEEK cell body. The cell constant has a nominal value of 160 cm^{-1} and is calibrated electronically. A sensor positioned slightly downstream from the electrodes senses the temperature of liquid passing through the cell. The measured value is used to provide temperature compensation.

The advanced geometry of the cell provides several benefits:

- Excellent accuracy and linearity over the working range
- Efficient sweepout and low volume for low dispersion
- Reduced sensitivity to electrode surface conditions
- Low electrode mass
- Effective temperature compensation

Dionex recommends installing the cell in an LC25 Chromatography Oven. The LC25 maintains a constant temperature, thus reducing the effects of variations in laboratory temperature.

Temperature Control and Compensation

Temperature directly affects the conductivity of a solution. As conductivity increases, the effect of temperature changes becomes more pronounced. For example, building temperature control systems can cause a regular oscillation in the baseline. This, in turn, can affect the reproducibility of an analysis.

In ion chromatography, suppressing eluent conductivity minimizes the effect of temperature variation. Temperature compensation further improves temperature stability. When the conductivity cell is installed in an LC25 Chromatography Oven, the LC25 enhances the ability of these techniques to reduce temperature effects below the detection limit.

Temperature compensation also ensures that there is no major change in the baseline or in peak heights, should it be necessary to change the LC25 operating set point. Readings will be normalized to 25 $^{\circ}\text{C}$ (77 $^{\circ}\text{F}$).

2.6 Vacuum Degas Pump Assembly (Optional)

The vacuum degas pump provides continuous on-line vacuum degassing of eluent. By default, the pump turns on for 2 minutes when the IC25 is powered up. Thereafter, it turns on for 30 seconds at 10-minute intervals. Change the cycle time and duration from the **DEGAS OPTIONS** screen (see Section C.1.7). Check the vacuum chamber pressure on the **DEGAS PUMP CALIBRATION** screen (see Section C.3.4).

The degas pump assembly consists of:

- A single-channel or dual-channel degas chamber (with degas membranes) with 17 mL fluid path per channel
- A dual-stage diaphragm vacuum pump
- A solenoid valve
- An on-board vacuum sensor
- The electronics required to operate the vacuum pump
- Fittings, tubing, and other accessories

Although these components are made of inert or corrosion-resistant materials, Dionex recommends thoroughly flushing any chemicals out of the tubing with deionized water before shutting down the IC25. This helps prevent crystallization in the membrane pores.

2.7 Eluent Reservoirs

Dionex strongly recommends degassing all eluents and storing them in reservoirs pressurized with helium. This helps prevent bubbles (resulting from eluent outgassing) from forming in the eluent proportioning valves, pump heads, and detector cell.

Degassed eluents and pressurized reservoirs are especially important when combining aqueous and nonaqueous components, such as water and acetonitrile. Pressurizable reservoirs allow eluents to be stored under a specific atmosphere.

Two optional E01 Eluent Organizers (P/N 044125) can fit on top of the IC25. Each organizer can contain any two of these reservoirs:

- 1-liter glass reservoir with shatterproof plastic coating (P/N 044126)
- 2-liter glass reservoir with shatterproof plastic coating (P/N 044127)
- 1-liter plastic reservoir (P/N 044128)
- 2-liter plastic reservoir (P/N 044129)



Do not use the 2-liter plastic reservoir (P/N 044129) for off-line vacuum degassing of eluents. The reservoir was not designed for this purpose.

Refer to the *Pressurizable Reservoir Installation Instructions* for installation details.

2.8 Rear Panel

The main power receptacle (including fuses), DX-LAN connector, and service chases for cables and tubing are on the IC25 rear panel. The rear panel is shown in Figure B-1.

2.9 Functional Description

2.9.1 Operating and Control Modes

The operating mode determines *how* the IC25 receives operating commands:

- In Local mode, the IC25 receives commands from the front control panel buttons and screens.
- In Locked Remote mode, PeakNet 6 software sends commands from the host computer via the DX-LAN interface.

The control mode determines *when* operating commands are executed.

- In Direct control, the IC25 executes commands immediately.
- In Method control, the IC25 executes commands according to the timed steps in a method. The method is programmed from the IC25 front panel.

The table below summarizes the various operating and control mode configurations. Select the modes from the **MAIN** screen (see Section C.1.2), **DETAIL** screen (see Section C.1.3), or chromatography software.

Operating/Control Mode	Detector Operation
Local/Direct Control	Commands are entered from the IC25 front control panel and executed immediately after being entered.
Local/Method	Commands are entered from the IC25 front control panel and executed by running a method programmed from the front panel.
Locked Remote/Direct Control	Commands are sent from PeakNet 6 and executed immediately when received.

2.9.2 Operating Modes

Local Mode

When the IC25 is powered up, it is in Local mode. In Local mode, the IC25 accepts operating commands from two sources:

- Direct input from the front panel keypad
- TTL inputs from a remote controller, such as an integrator

Locked Remote Mode

In Locked Remote mode, the IC25 accepts operating commands from the host computer via the DX-LAN.

In Locked Remote mode, all operating changes from the IC25 front panel are disabled. Selecting the Connect command from PeakNet 6 immediately selects the Locked Remote mode. To return the IC25 to Local mode, select the Disconnect command, or turn off the IC25 power.

2.9.3 Method Control

In Method control, commands are executed according to the time-based steps programmed in a method. Each step specifies the flow rate to be delivered by the IC25 at a given time, the TTL and Relay outputs, and the positions of the injection and eluent selection valves.

Methods are programmed, saved, and edited from the **METHOD** screen (see Figure 2-8). See Section 3.3 for programming instructions.

METHOD EDIT		1	SAVE TO		1	RUN		1
TEMP COMP		1.7	OVEN TEMP		25	SRS OFF		
TIME	V	ELU	RANGE	OFFSET	MARK	FLOW		
INIT	L	A	100 uS	*			1.00	>
0.00								>
1.00	L	A	200 uS		*		1.01	>
2.00	L	A	300 uS	*	*		1.02	>
Help Message								

Figure 2-8. Method Screen

The following summarizes basic information about using methods:

- The IC25 can run under method control while you are entering or editing any method (including the one that is currently running).
- When saving changes to the currently running method, or switching to a different method, the method clock continues running unaffected. Only those parameter changes which affect the method after the current time will be implemented in the current run.
- The IC25 can store up to 100 separate methods (0 through 99) in memory. The actual number, which depends on the size of each method and the amount of available memory, is typically less than this.
- Methods are retained in memory even after the IC25 is powered down.
- Each method can have a maximum of 50 time-based steps. Step 1 always starts at **INIT** (initial conditions). Step 2 always starts at **TIME = 0.0**.

3 • Operation and Maintenance

3.1 Getting Ready to Run

NOTE The IC25 is designed for use with IC (ion chromatography) applications and should not be used for any other purpose. If there is a question regarding appropriate usage, contact Dionex before proceeding.

3.1.1 Degas Eluents

Dionex strongly recommends degassing all eluents and storing them in reservoirs pressurized with filtered inert gas (see Section 3.1.3). This helps prevent bubbles caused by eluent outgassing from forming in the eluent proportioning valves, pump heads, and detector cell. Degassed eluents and pressurized reservoirs are especially important when combining aqueous and nonaqueous components (e.g., water and acetonitrile).

The IC25 with the optional vacuum degas pump assembly continuously degasses eluents. If you have a standard IC25, manually degas eluents daily, as described below, and store them in pressurized reservoirs.

Degassing Eluents Manually

1. Prepare the eluent required for the application. Pour it into a vacuum flask and attach the flask to a vacuum pump or water aspirator.
2. Vacuum-degas the eluent for 5 to 10 minutes in addition to shaking or sonication.
3. Remove the flask from the vacuum. **Do not allow water to flow from the aspirator back into the flask.**
4. Pour the degassed eluent into a pressurizable reservoir. Be careful not to shake the eluent.
5. Install end-line filters and pressurize the reservoirs (see Section 3.1.2 and Section 3.1.3).

3.1.2 Filter Eluents

Always filter eluents with a 0.45 μ filter before use. This removes small particulates that may contaminate the pump check valves and cause erratic flow rates or loss of prime. For additional protection, end-line filters (P/N 045987) are supplied in the pressurizable reservoir Ship Kits for filtering during operation.

Install an end-line filter on the end of the eluent line inside the reservoir. To prevent air from being drawn through the line, make sure the end of the filter reaches the bottom of the eluent reservoir.

3.1.3 Pressurize Eluent Reservoirs

The IC25 is capable of operation with or without head pressure on the eluent reservoirs. However, vacuum degassing of the eluent is essential for optimum pump performance. Pressurization of the eluent reservoirs, if used, should be with filtered inert gas, preferably helium. Refer to the *Pressurizable Reservoir Installation Instructions* for details.

1. Verify that a regulator (P/N 051997) is installed on the gas supply line to the reservoirs.
2. Turn on the gas supply and adjust the pressure to 55 KPa (8 psi).



Never pressurize eluent reservoirs above 69 KPa (10 psi).

3.1.4 Start-Up

1. Turn on the IC25 power. The **POWER-UP** screen is displayed briefly and then some diagnostic tests begin running. If the tests are successfully completed, the **MAIN** screen appears after a few seconds. If one or more tests fails, the **DIAGNOSTIC TEST** screen appears, instead.
2. Set the LC25 temperature from the **MAIN** screen. Allow about 30 minutes for the LC25 to reach its upper limit of 45 °C (113 °F).
3. Set the desired flow rate. Press **Pump On** to start the pump flow.
4. Set the SRS current. The SRS power is off when the IC25 is initially powered up.
5. Check the pressure reading on the **MAIN** screen. The IC25 display updates the pressure readout once per piston stroke. The reading from one stroke to the next should be within 3% of the total pressure reading. A variation of more than 3% may indicate that the pump is not primed. Refer to Section 4.1 for conditions which can cause the pump to lose prime.

NOTE Wait at least 5 minutes (up to 30 minutes for low flow rates) after starting the pump or changing the flow rate before beginning an analysis. This delay allows the real-time electronic pulse damping circuitry to stabilize the flow rate.

3.1.5 Selecting the Pressure Limits

The high and low pressure limits automatically stop the pump in the event of a system malfunction, such as low pressure caused by a leak downstream from the pump or overpressurization due to a blockage.

When running under Direct control, enter the pressure limits from the **MAIN** or **DETAIL** screen.

When running under Method control, enter the limits from the **METHOD** screen as a part of each method. The limits are set in the **INIT** step and remain unchanged throughout an analysis. When a limit trip stops the pump, the method clock immediately stops and goes to hold. The current status of the method that was running at the time is displayed on the front panel.

1. Open the **MAIN** or **METHOD** screen and move the cursor to the **LIMIT** field.
2. Enter a low pressure limit that is 2.1 to 3.4 MPa (300 to 500 psi) below the normal system operating pressure, as indicated by the pressure display on the front panel. This setting may vary, depending on the system operating pressure. The low pressure limit will be activated after 13 pump piston strokes of fluid (1.3 mL) have been pumped through.

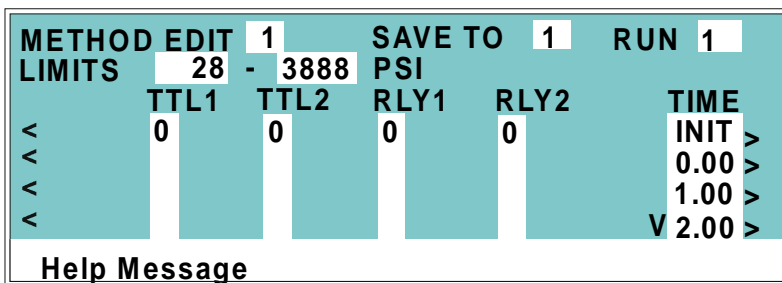

Figure 3-1. Method Screen: Setting Pressure Limits

3. Enter a high pressure limit that is 2.8 to 3.4 MPa (400 to 500 psi) above the maximum normal system operating pressure. The IC25 is equipped with a pressure limit to prevent operation above 35 MPa (5076 psi).

3.2 Running Under Direct Control (Local Mode)

In the Direct control operating mode, commands are carried out immediately after they are entered. Changes to operating parameters remain in effect until new commands are entered. Because there are no time-based steps, the method clock is not used and the **Run Method** and **Reset** buttons do not operate.

To select Direct control, open the **MAIN** screen.

- If **DIRECT CNTRL** is displayed, the IC25 is already in Direct control mode and no further action is necessary.
- If **METHOD** is displayed, move the cursor to **METHOD** and press **Select** ∇ or **Select** Δ to toggle to **DIRECT CNTRL**. Press **Enter** or a cursor arrow button to activate the selection.

To issue commands from the IC25 keyboard or from TTL or relay input, the IC25 must be in Local control mode. Verify that the **MAIN** screen is displaying **LOCAL**. If **REMOTE** is displayed, press the **Local/Remote** button to change the mode.

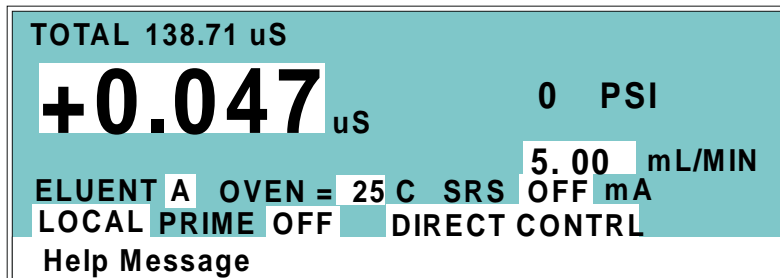

Figure 3-2. Main Screen: Direct Control Mode

3.3 Running Under Method Control (Local Mode)

In the Method control operating mode, a series of programmed timed events, known as a *method*, controls the IC25. Methods are retained in memory even after the IC25 power is turned off.

This section explains how to create, edit, and run methods. Examples for creating a method and modifying an existing method are included.

Observe the guidelines below when entering time-based parameters on the **METHOD** screen (see Figure 3-3).

- The **TIME** field is the only field in a method step that must have an entered value. A blank field in any other step indicates no change from the value set in the previous step.
- When setting method times, allow at least 15 left-to-right piston transitions after starting the pump or changing the flow rate before beginning an analysis. This allows the pump's real-time electronic pulse damping circuitry to stabilize the flow rate. The stabilization time is 10 minutes or more for medium to fast flow rates. For slow flow rates, the stabilization time may be as long as 30 minutes. Monitor the left-to-right piston transitions from the **DSP STATUS** screen.
- In the **V** column, select the position of the injection valve (either **L** for load or **I** for inject).
- In the **ELU** column, select the eluent (either **A** or **B**).
- The **TTL** and **RLY** columns control functions in external devices that are connected to the IC25. To turn on a TTL or relay function, set the value to **1**. To turn off a function, set the value to **0**. For example, if **TTL1** is connected to the load function on an autosampler, setting **TTL1** to **1** sends the signal to the autosampler to start the load cycle. See Appendix D for details about TTL and relay control.
- In the **FLOW** column, enter the pump flow rate. The range is 0.04 to 10.0 mL/min, adjustable in increments of 0.01 mL/min.
- When a method contains more steps than can be displayed on one screen, they are scrolled off the screen. A small arrow down (v) next to the time entry at the bottom of the screen indicates there are additional steps below. A small arrow up (^) adjacent to the top time entry indicates there are additional steps

above. To view the additional steps, move the cursor to the bottom or top of the screen and then move one more line.

3.3.1 Creating a New Method

New methods can be created when the method clock is in either hold or run.

1. Open the **MAIN** screen.
2. Make sure the selected operating mode is **LOCAL**. If **REMOTE** is set, press the **Local/Remote** button.
3. Open the **METHOD** screen.
4. In the **EDIT** field, enter the number of the method to be created. This may be the number of an unused method, or else the number of an existing method that you want to edit and then save as a new method.
5. In the **TEMP COMP** field, set the temperature compensation factor to between 0 and 3%.
6. If the cell is installed in the LC25 Chromatography Oven, move the cursor to the **OVEN TEMP** field and set the temperature.
7. In the **SRS** field, turn the suppressor on or off.
8. Each method begins with two timed steps (see Figure 3-3). The first is an initial conditions step with **INIT** in the **TIME** column; the second is a time zero step with **0.00** in the **TIME** column. The parameters in the first two steps can be changed but the steps cannot be deleted. Enter the parameters for these two steps now.

METHOD EDIT	1	SAVE TO	RUN
TEMP COMP	1.7	OVEN TEMP	25
TIME	V ELU	RANGE	OFFSET MARK FLOW
INIT	L A	100 uS	* 1.00 >
0.00			>>>
Help Message			

Figure 3-3. Method Screen: Creating a New Method

9. To enter a new step, use one of the following methods:
 - Move the cursor to the empty **TIME** field below the last step and enter the elapsed time at which to start the new step.
 - Move the cursor to any **TIME** field and press **Insert**. This adds a new step after the cursor position. Enter the elapsed time at which to start the new step.

After you press **Enter** or a cursor arrow button, timed steps are automatically organized in chronological order.

10. Enter the remainder of the parameters for the new step.
11. After entering the time-based parameters, move the cursor to the **SAVE TO** field. If this is an existing method, enter a new number and press **Enter** to save the method to the new number. If the method number was previously unused, press **Enter** to save the method.

Example: Creating a Method

Run the pump at 2.0 mL/min for 5 minutes. At 5 minutes, inject the sample and lower the flow rate to 1.0 mL/min.

1. Open the **METHOD** screen, enter a method number in the **EDIT** field (1, for example), and press **Enter**. The number in the **SAVE TO** field will change automatically to match the number of the method being edited.
 - If method 1 currently exists and you want to delete it, move the cursor to **TIME=INIT** and press **Delete** twice. This deletes the entire method.
 - If you want to retain the original method 1, enter a new, unused, method number in the **EDIT** field.
2. Move the cursor down to **INIT** and then right to **V**. If necessary, press **Select** Δ to toggle to **L** (load), and press **Enter**. Move to **FLOW** and enter 2 to set the flow rate to 2.00 mL/min.
3. Position the cursor in the blank time step below **TIME=0.00**. Enter a 5. Move to the **V** field and press **Select** Δ to toggle to **I** (inject). Move to **FLOW** and enter 1 to set the flow rate to 1.00 mL/min.
4. Move the cursor to **SAVE TO** and press **Enter** to save the method.

3.3.2 Running a Method

1. If the pump motor is off, press **Pump On** to turn on the motor.
2. Open the **MAIN** screen and, if necessary, toggle from **DIRECT CNTRL** to **METHOD** and from **REMOTE** to **LOCAL**.
3. In the **METHOD** field, enter the desired method number.

Or, to select the method number from the **METHOD** screen, move the cursor to **RUN** and enter the desired method number.

- If the method clock is already running when the method number is entered, the method starts immediately.
 - If the method clock is in hold, press **Run Method** to start the method.
4. The elapsed time on the method clock when the method begins determines where (at what step and parameters) the method begins running:
 - If the method clock is at **INIT** or time zero, the method begins running using the initial condition parameters.
 - If the method clock is greater than zero, the method begins running using the parameters specified in the step for that elapsed time. Press **Reset** to start the method at the initial conditions.

3.3.3 Controlling the Method Clock

- To start and stop the method clock, press **Run Method**.
- To reset the clock to **INIT**, press **Reset**.
- To set the clock to a specific elapsed time, enter the time in the **MIN** field on the **MAIN** screen. The method will start (or continue) running, using the method parameters specified for that time.

3.3.4 Editing a Method

You can modify, add, or delete steps and/or parameters in an existing method at any time, even while the method clock is running. If the method being edited is currently running, the changes are stored in memory and then implemented when the method is saved.

NOTE After saving changes to a method, there is no way to recall the original method. Therefore, when editing an existing method that you also wish to retain in its unmodified form, save the modified method under a new method number.

These are the basic steps for editing a method:

1. Open the **METHOD** screen. In the **EDIT** field, enter the number of the method to be modified.
2. Make changes as needed:
 - To change a field's value, position the cursor in the field and enter a new value. This automatically deletes the previous value.
 - To add a method step, move the cursor to any of the **TIME** fields and press **Insert**, or move the cursor to the empty **TIME** field below the last step and enter the elapsed time at which to start the new step. After you press **Enter** or a cursor arrow button, the new step is automatically moved to the correct chronological position. Continue entering parameters for the new step.
 - To delete a method step, move the cursor to the step to be deleted and press **Delete** twice.
3. When changes are complete, move the cursor to the **SAVE TO** field. Press **Enter** to save the changes to the current method, or enter a new method number and press **Enter**.

When changes to the currently running method are saved, they are immediately incorporated into the run and executed at the programmed time. However, if a change is made to an event after it has been executed, it cannot be incorporated into the current run. To run the new version of the method, press **Reset** to restart the method at the **INITIAL** conditions.

3.3.5 Deleting a Method

To delete an entire method, move the cursor on the **METHOD** screen to the **INIT** step, and then press **Delete** twice.

3.3.6 Changing the Running Method

To switch from the method currently running to a different method, enter the new method number in the **RUN** field on the **METHOD** screen and press **Enter**. The new method begins running using the parameters specified in the step for the current elapsed time. Press **Reset** to start the method at the **INIT**ial conditions.

3.4 Optimizing Temperature Compensation

The IC25 built-in temperature compensation stabilizes conductivity readings by correcting for changes in ambient temperature that occur during a run.

Housing the conductivity cell in the LC25 Chromatography Oven ensures that there is no more than a minor temperature variation in liquid reaching the cell, so the **TEMP COMP** setting on the **DETAIL** screen can remain at 1.7% per °C.

Many users are able to stay at a single operating temperature. For optimal accuracy, calibrate the cell at this temperature (see Section 5.8), using the proper temperature coefficient setting. If the temperature is later reset, the IC25 temperature compensation will normalize conductivity measurements to 25 °C (77 °F) to prevent a major upset in system calibration. If the LC25 set point is changed, recalibrate the cell.

If temperature-induced baseline cycling occurs, it is probably caused by another component of the chromatography system. If the variation increases as the eluent reservoir empties, move the reservoir to a more temperature-stable environment and/or wrap the reservoir in thermal insulation.

3.5 Shutdown

- Rinse the pump pistons after daily operation to prevent build-up of salt crystals or other contaminants that can damage the piston seal (see Section 3.6.1).
- If the IC25 will not be used for three days or more, flush the system with deionized water to prevent contaminants from building up.
- If the shutdown is for more than three days, reduce the pressure on the eluent reservoir(s) to about 21 KPa (3 psi).
- Turn off the main power.

3.6 Routine Maintenance

This section describes routine maintenance procedures to be performed by the user. Any other maintenance procedures must be performed by qualified Dionex personnel.

3.6.1 Daily Maintenance

- After operation with a combination of eluents containing both salt or base and solvent, rinse the piston frequently or continuously. Eluent tends to crystallize as the solvent evaporates. These crystals can abrade the piston, causing the main seal to leak. Rinse the piston before and after daily operation, as described below.
 1. Open the lower door of the IC25 and locate the rinse ports on the front of the pump heads (see Figure 3-4).
 2. Install the two rinse waste tubes (P/N 054418) provided in the IC25 Ship Kit onto the heads. Place the end of each tube into a waste container.
 3. Attach a small syringe (P/N 054578) containing 5 to 10 mL of deionized water to one of the female luer fittings.
 4. Inject deionized water into the fitting. Water will flow through the first head, through the short connecting tubing to rinse the second head, and out to waste.
 5. Remove the syringe and dispose of the waste water. Close the door to the mechanical chassis.

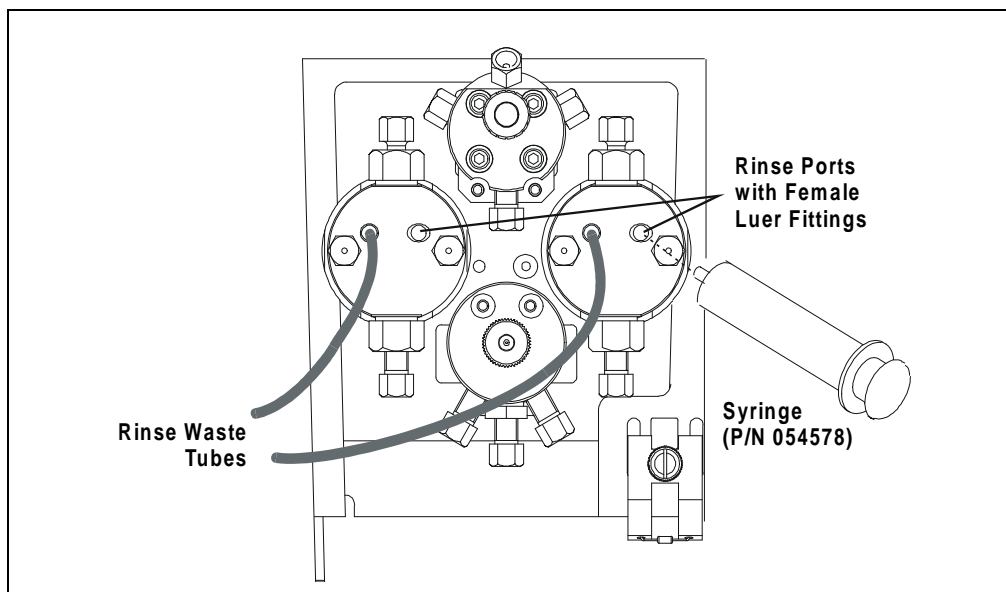

Figure 3-4. Rinsing the Pump Heads

- All components of the optional vacuum degas assembly are made of inert materials or corrosion-resistant materials. To avoid crystallization in the membrane pores, thoroughly flush any chemicals out of the vacuum degas chamber(s) and tubing with deionized water after each use.
- Check the entire mechanical chassis for leaks from the rinse ports, the vacuum degas chamber(s), and the eluent reservoir (see Figure 3-5). Tighten or replace any leaking fittings. Wipe up liquid spills and rinse dried reagents off pump components with deionized water.

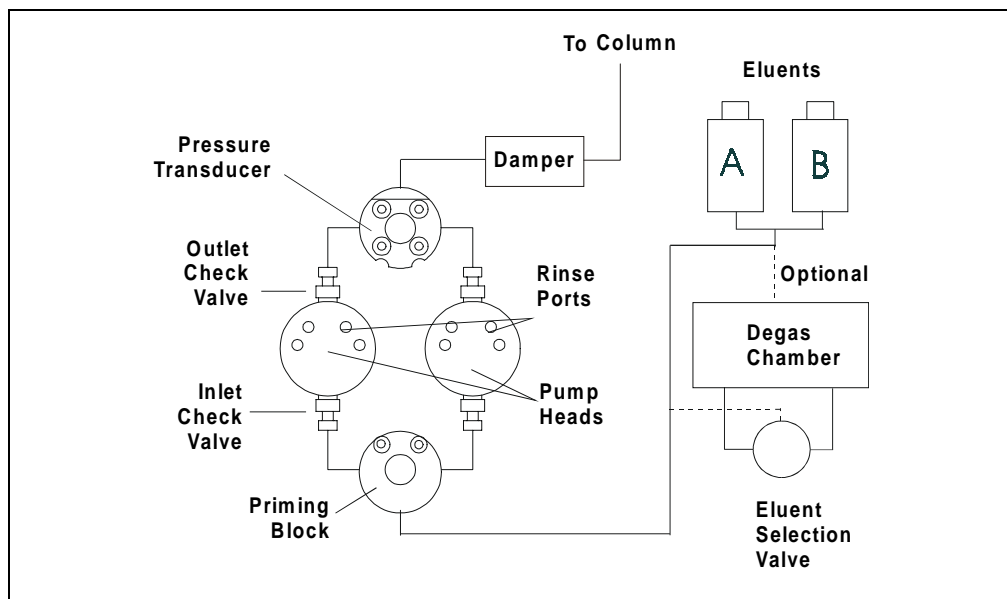

Figure 3-5. Eluent Flow Schematic

3.6.2 Periodic Maintenance

Replace both the primary piston seals and rinse seals in each pump head approximately every 6 months (see Section 5.3). A drop of eluent trapped in the end of the drain tubes is normal, but eluent flowing from the tubing indicates a leak.

IMPORTANT

The seals may need to be replaced more often if you operate the pump continuously, or if you routinely run at high pressure or high flow rates.

4 • Troubleshooting

This chapter is a guide to troubleshooting routine problems that may occur while operating the IC25 Ion Chromatograph. To use this guide, turn to the section that best describes the operating problem. There, the possible causes of the problem are listed in order of probability, along with the recommended courses of action.

If you are unable to eliminate a problem, contact Dionex for help. In the U.S., call Dionex Technical Support at 1-800-346-6390. Outside the U.S., call the nearest Dionex office.

4.1 Left-Right Pump Head Pressure Fluctuations

The IC25 display updates the pressure readout once per piston stroke. A variation of more than 3% of the total pressure reading from one stroke to the next indicates a problem.

- **Pump out of prime; there is no eluent**
 1. Refill the eluent reservoir. Verify that the eluent line extends to the bottom of the reservoir.
 2. Prime the pump (see Section B.5).
- **Pump out of prime; eluent is improperly degassed**

If the IC25 does not include the optional degas pump assembly, degas the eluents manually (see Section 3.1.1) and then prime the pump (see Section B.5).
- **Pump is out of prime; liquid line leak**

Check for liquid leaks (see Section 4.4). Tighten fittings or replace lines.
- **Pump is out of prime; end-line filter is dirty or clogged**
 1. Replace the filter (P/N 045987).
 2. Prime the pump (see Section B.5).

- **Pump is out of prime; blockages in inlet tubing.**
 1. Check for kinked or clogged tubing and replace.
 2. Prime the pump (see Section B.5).
- **Priming did not eliminate excessive pressure fluctuations; dirty or defective piston seal or check valves**
 1. Follow these steps to isolate the cause:
 - a. If leaks are seen from the piston rinse tubes, replace the piston seals (see Section 5.3).
 - b. If no leaks are seen, replace the check valves (see Section 5.2). Dirty or defective check valves can be caused by impurities in the eluents. Install end-line filters (P/N 045987) to prevent this.



Observe the warning label on the inside of the mechanical chassis door. The arrows on the label indicate moving mechanical parts that present pinch hazards when the pump is on and the drawer is open. Do not touch any parts within the mechanical chassis while the pump is on.

- c. Slide open the mechanical chassis drawer. If a piston does not move when there is pump flow, examine it for breakage and replace if necessary (see Section 5.4). If a piston moves, examine it for scratches and replace if necessary. If a piston moves slightly and then breaks contact with the rocker arm follower (the cylinder holding the piston in place as it moves in and out of the pump head assembly), replace the piston seal (see Section 5.3).
- d. Push the mechanical chassis drawer back in place and make sure the cables are not pinched. Retighten the drawer lock and turn on the main power switch.

4.2 Pump Will Not Start

- **Flow rate is set to zero**

Select a flow rate from 0.04 to 10.0 mL/min.

- **While being primed, pump starts briefly, then stops because of high pressure limit**
 1. Check the high pressure limit setting (see Section 3.1.5).
 2. Replace any crimped or blocked tubing downstream from the pressure transducer. If there is none, go on to Step 3.
 3. Open the pressure transducer waste valve by turning the knob counterclockwise about two turns (see Figure 2-6). Check the pressure reading; if it is above 97 KPa (14 psi), recalibrate the pressure transducer (see Section C.3.6).
 4. Select a lower flow rate or, when safe to do so, increase the high pressure limit.

4.3 Pump Stops

- **Method or other remote input instructed the pump to stop**

Check the display screen for error messages. If no error message is displayed, the pump was probably instructed to stop by the method, computer, or other remote signal source.

- **Electrical cables improperly installed**
 1. Place the IC25 in **LOCAL** mode, **DIRECT CONTROL**. Press **Pump On** to start the pump.
 2. If a non-zero flow rate is displayed and the **Pump On** LED is illuminated, verify that the electrical cables in the mechanical chassis are properly installed.
 - a. Turn off the main power switch.
 - b. Using a 7-mm open-end wrench or your fingers, loosen the mechanical chassis drawer lock on the lower right side of the chassis (see the label on the inside of the lower door).
 - c. Pull out the drawer a few inches.

- d. Verify that all cables are seated properly in the connectors on the distribution card located on the top of the mechanical chassis.
 - e. Push the mechanical chassis drawer back in place, making sure the cables are not pinched. Retighten the drawer lock. Turn on the power.
- **Low pressure limit was tripped. The following message is displayed:**

Low Pressure Limit Violation

1. Check the low pressure limit setting (see Section 3.1.5).
2. If the eluent reservoir is empty, refill it. Prime the pump before resuming operation (see Section B.5).
3. Make sure the waste valve on the pressure transducer is closed by turning the knob on the pressure transducer housing clockwise (see Figure 2-6).



Overtightening the pressure transducer waste valve may damage the valve and the pressure transducer housing.

4. Make sure there are no liquid leaks in the flow system.
5. Place the IC25 in **LOCAL** mode, **DIRECT CONTROL**. Press **Pump On** to start the pump. Verify that the pistons are moving and that you can hear the pump.

If there is no sound from the pump, check the LED on the CPU card inside the door to the electronics chassis (see Figure 2-5). A red LED indicates a defective power supply. The power supply (P/N 046440) must be replaced by qualified personnel. Contact Dionex.

6. With the pump running, open the **MAIN** screen and note whether the left-right pressure varies by more than 3% between strokes. If it does, refer to Section 4.1. If it does not, either increase the flow rate or reduce the low pressure limit setting and then resume operation.

- **High pressure limit was tripped. The following message is displayed:**

High Pressure Limit Violation

1. Check the high pressure limit setting (see Section 3.1.5).
2. Isolate segments of the flow path to determine the source of the high pressure.
 - a. First, remove the pump inlet tubing from the injection valve.
 - b. Turn on the pump and record the pressure reading.
 - c. Add in each segment of the remaining flow path until the source of the high pressure is determined.
 - d. Replace any tubing, fittings, and components necessary to resume standard operating pressure.
 - e. If the source of the high pressure is the column, refer to the column manual for troubleshooting procedures. Replacement may be required.
3. Open the pressure transducer waste valve by turning the knob counterclockwise about two turns (see Figure 2-6). If the pressure reading is above 97 KPa (14 psi), recalibrate the pressure transducer (see Section C.3.6).

- **An error message beginning with “DSP” displays:**

Several messages are related to DSP (Digital Signal Processor) errors, for example, “DSP communication fails” and “DSP does not acknowledge.” When one of these messages is displayed, follow the procedure below.

1. Turn off the main power to the IC25.
2. Verify that the DSP card is properly installed in slot 1 of the electronics chassis card cage (see Figure 2-5).
3. Turn on the main power to the IC25. If the DSP error message reappears, notify Dionex. The power supply (P/N 046440), DSP card (P/N 045369), or CPU card (P/N 046340) may need replacing.

IMPORTANT

Do not remove any of the electronic cards from the IC25. There are no user-serviceable components on the cards. Servicing must be performed by qualified Dionex personnel and appropriate electrostatic discharge (ESD) handling procedures must be followed.



The CPU card contains a lithium battery. If the CPU card is replaced, dispose of the used battery according to the manufacturer's instructions

- **The following error message displays:**

Motor Drive Fails

If the pump motor is in a runaway condition, the motor automatically shuts off and the above error message is displayed. Contact Dionex for assistance.

- **The following error message displays:**

Encoder Index Not Found

1. Turn off the main power to the IC25.
2. Verify that the cables connected to the DSP card in the electronics chassis (see Figure 2-5) are seated properly.
3. Turn on the main power to the IC25. If the error message reappears, notify Dionex.

4.4 Liquid Leaks/Leak Alarm

- **Leaks from the front rinse ports or rear of the pump head indicate a defective piston seal**

Replace the piston seal and rinse seal (see Section 5.3).

- **Leaks from any connection between the eluent reservoir and the pump heads indicates an eluent leak (see Figure 3-5)**

Tighten the fitting connections just enough to stop the leak.

- **Pressure transducer leaks**

Inspect the pressure transducer. If the leak is from the waste valve, replace the waste valve O-ring (see Section 5.5). If the leak is from the rear of the transducer, contact Dionex.

- **Priming valve leaks**

Tighten any leaking fittings just enough to stop the leak. Replace any defective tubing assemblies. If this does not stop the leak, the priming block assembly (P/N 054086) must be replaced by qualified personnel. Contact Dionex for assistance.

- **Interior mechanical chassis leaks**

Inspect the chassis for leaks. Tighten any leaking fittings and replace any damaged parts.

4.5 High-Pitched Noise From Pump Motor (or Motor Racing)

- **DSP (digital signal processing) card current limit has been exceeded**

A built-in current limiter on the card protects the motor and motor drive. Check the three small LEDs located in the upper left corner of the DSP card bulkhead. (The DSP card is in slot 1 of the electronics chassis card cage.) If the bottom LED is flashing in time with the pump strokes, the current limiter is being activated.

As the pump motor ages, it becomes less efficient and the current limit is activated more frequently. Activating the current limit is harmless; however, if it occurs frequently, even at low speeds and/or pressures. Contact Dionex for assistance.

- **Pressure servo oscillation**

Open the **DSP STATUS** screen and verify that the correct pump head volume and head material are selected. If the settings are correct but the problem persists, contact Dionex for assistance

- **Out of prime**

Reprime the pump (see Section B.5).

4.6 Vacuum Degas Pump Does Not Run

- **DEGAS OPTIONS screen settings incorrect**

Open the **DEGAS OPTIONS** screen (press **Menu, 4, 4**). If the **DEGAS PUMP** field is set to **ALWAYS OFF**, select **BY SETTING** and enter the desired cycle duration and frequency times. By default, the degas pump runs for 2 minutes when the IC25 is powered up. Thereafter, it runs every 10 minutes for 30 seconds.

- **Electrical cables improperly installed**

The vacuum degas pump should turn on and run for about 45 seconds. If it does not run, verify that the cables connected to the pump in the electronics chassis and in the mechanical chassis are properly connected.

1. Turn off the main power switch.
2. Using a 7-mm open-end wrench or your fingers, loosen the mechanical chassis drawer lock on the lower right side of the chassis (see the label on the inside of the lower door). Pull out the drawer a few inches.
3. Check that all cables are seated properly in the connectors on the distribution card located on the top of the mechanical chassis.
4. If the connections are correct, the distribution card may need to be replaced. Contact Dionex for assistance.
5. Push the mechanical chassis drawer back in place, making sure the cables are not pinched. Retighten the drawer lock.

4.7 Vacuum Degas Pump Calibration Fails

- At the end of the degas calibration, the **DEGAS READING** value is less than **13000 counts** and one of the following error message appears:

Degas vacuum pump is not present or degas
circuitry is malfunctioning.

Vacuum Degas Fails

Verify that the cable to the vacuum degas pump is connected to the distribution card in the mechanical chassis.

1. Turn off the main power switch.
2. Using 7-mm open-end wrench or your fingers, loosen the mechanical chassis drawer lock on the lower right side of the chassis (see the label on the inside of the lower door). Pull out the drawer a few inches.
3. The distribution card is on the top of the mechanical chassis. Labels printed on the card identify the various cables plugged into it. The connector for the vacuum degas pump, labeled **VAC PUMP**, is near the right rear corner of the card. Check the connection.
4. Push the mechanical chassis drawer back in place, making sure the cables are not pinched. Retighten the drawer lock.
5. Turn on the main power switch.
6. Retry the calibration. If the message reappears, contact Dionex for assistance.

4.8 Vacuum Degas Pump Low Vacuum

The IC25 monitors the degas vacuum once a minute. If the reading is 2000 counts or more below the degas calibration value, the following message is displayed:

```
LOW VACUUM ALARM!!  
Check DEGAS OPTIONS settings or refer to  
operator's manual
```

Open the **DEGAS OPTIONS** screen (press **Menu, 4, 4**). Try increasing the **CYCLE DURATION** time and/or decreasing the **TIME BETWEEN CYCLES**. If this does not solve the problem, contact Dionex for assistance.

4.9 Inoperative Relay Control Function

- **Incorrectly installed cables**

Make sure the cables between the appropriate relay function and the input or output unit are properly connected (see Appendix D).

- **Method programming error**

Refer to Chapter 2 and Appendix C.

- **When attempting to set TTL2, the following message appears:**

```
TTL2 is set to indicate FLOW/NO FLOW.
```

The **TTL2 OUTPUT USAGE** field on the **PUMP OPTIONS** screen is currently set to signal when pump flow stops (**0 FLOW**). This setting is used to control the power to a Self-Regenerating Suppressor (SRS). To use TTL2 for another function, open the **PUMP OPTIONS** screen and set the **TTL2 OUTPUT USAGE** field to **NORMAL**.

4.10 Poor Chromatographic Reproducibility

- **Liquid lines incompletely flushed after an eluent change**

Attach a syringe to the priming block and draw at least 2.5 mL (20 mL if the vacuum degas pump is installed) of the new eluent through the liquid lines before beginning operation.

- **Leaking piston seal**

Check for liquid leaks at the rinse ports in the front of the pump heads (see Figure 3-5). Replace the piston seal on any head with a leak (see Section 5.3).

- **Equilibration time too short**

Wait at least 10 minutes after starting the pump or changing the flow rate before beginning an analysis. This allows the pump's real-time electronic pulse damping circuitry to stabilize the flow rate.

4.11 No Detector Response

- **Cell is off**

Turn on the cell (from the **MAIN** screen).

- **Analog output range set too high; although the display indicates a response, no recorder response observed**

Select a more sensitive analog output range.

- **Wrong full-scale output (or no full-scale output) selected**

Select 0.01, 0.10, or 1 volt full-scale.

- **No flow from pump**

Check the pressure reading on the pump to verify that the pump is on.

- **Detector offset out of range**

Press **Offset** on the IC25 front panel.

4.12 Low Detector Output

- **Analog output range set too high; although the display indicates a response, no recorder response observed**

Select a more sensitive analog output range.

- **Insufficient sample injected**

Increase the injection size or concentration.

- **Cell out of calibration**

Recalibrate the cell (see Section 5.8).

4.13 High Detector Output

- **Auto offset not activated recently**

Press **Offset** on the IC25 front panel before making an injection.

- **Background not suppressed by SRS**

Check the SRS regenerant out line for bubbles. If there are no bubbles, the suppressor may not be functioning properly. Refer to the SRS manual for troubleshooting guidance.

4.14 Noisy or Drifting Baseline

- **Flow system leak ahead of cell; erratic baseline**

Check all fittings and liquid lines for leaks. Tighten or, if necessary, replace all liquid line connections. If the connections are made with ferrule fittings, first refer to *Installation of Dionex Ferrule Fittings* for tightening requirements.

- **Pump not properly primed**

Prime the pump (see Section B.5).

- **Rapid changes in ambient temperature**

Redirect heating and air conditioning vents away from the cell.

- **Insufficient system equilibration following any changes to operating parameters; especially apparent when operating at high sensitivities**

Allow longer system equilibration before beginning operation.

- **Air trapped in cell; excessive pulses in baseline**

Remove the trapped air (see Section 5.7). To prevent air from becoming trapped in the cell again, increase backpressure on the cell by reducing the inner diameter of the tubing installed after the cell and before the SRS.

- **Inappropriate SRS operating conditions**

Check the SRS manual for the correct operating conditions.

- **Temperature compensation setting not optimized**

Optimize the selected setting.

4.15 Conductivity Inaccurate

- **Cell constant reported on CALIBRATE CONDUCTIVITY CELL screen after cell calibration is not 130 to 190 μS**

The LC25 has not reached its set point temperature. Set the intended operating temperature. The “Not Ready” message will be displayed until the cell reaches its set point. The entire enclosure will take longer to reach the set temperature, depending on the set point and the ambient temperature.

Make sure the selected temperature compensation setting is 1.7%/°C. Except at 25 °C, an incorrect temperature compensation setting can cause an incorrect reading.

The 1 mM KCl calibration solution is spoiled, or there was a mixing error. Remake the solution.

The electrodes are fouled by grease, precipitate, etc. Using a syringe, flush 5 mL of 3 M HNO₃ through the conductivity cell. Rinse thoroughly with water. Recalibrate the cell with 1 mM KCl.

The cell has internal leaks, or broken or shorted cell or sensor wires. Replace the cell.

- **Cell temperature readout deviates by more than 2°C from LC25 set temperature**

This indicates a serious cell or LC25 sensor problem. Contact Dionex for assistance.

4.16 Faulty DX-LAN Communication

- **DX-LAN interface incorrectly installed**

See Section B.2.2 for 10BASE-T installation instructions or Section B.2.3 for BNC installation instructions.

NOTE The IC25 electronics components are not customer-serviceable. All electronics-related repair procedures must be performed by Dionex personnel.



The CPU card contains a lithium battery. If the CPU card is replaced, dispose of the used battery according to the manufacturer's instructions.

This chapter describes routine service procedures for the IC25 mechanical components. Any procedure not described here must be performed by Dionex personnel.

Before replacing any part, check the troubleshooting information in Chapter 4 to isolate the source of the problem.

Substituting non-Dionex parts may impair IC25 performance, thereby voiding the product warranty. Refer to the warranty statement in the Dionex Terms and Conditions for more information.

5.1 Changing Main Power Fuses

1. Turn off the main power switch to ensure you do not unintentionally start the IC25.



HIGH VOLTAGE—Disconnect the main power cord from its source and from the IC25 rear panel.

2. The fuse holder is part of the main power receptacle on the rear panel of the IC25 (see Figure 5-1). A recessed lock is located on each side of the fuse holder. Using a small screwdriver, push each lock toward the center to release it. The fuse holder pops out slightly when the locks release. When both locks are released, pull the fuse holder straight out of its compartment.
3. The holder contains two fuses. Replace these with new IEC127 fast-blow fuses rated 3.15 amps (P/N 954745). Dionex recommends always replacing both fuses, even if only one has failed.
4. Reinsert the fuse holder into its compartment. The fuse holder is keyed to fit only in its proper orientation. Apply sufficient pressure evenly against the holder to engage the two locks. The holder is flush against the panel when both locks are engaged.
5. Reconnect the main power cord and turn on the power.

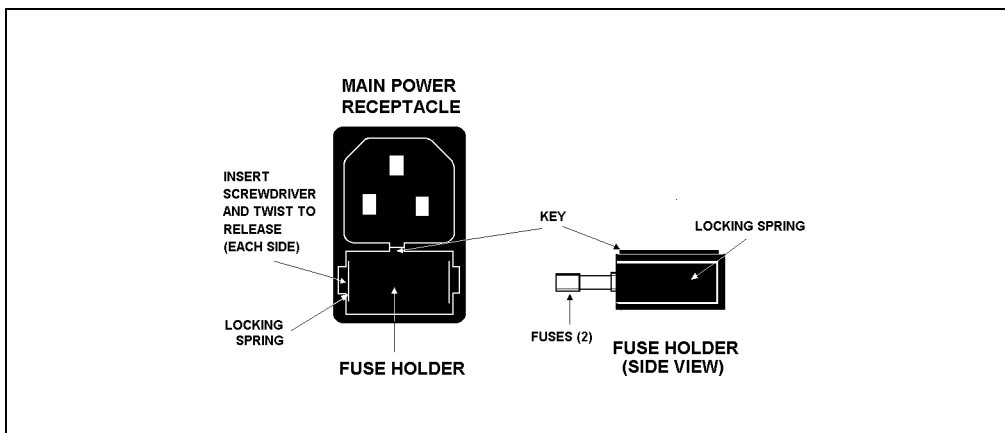

Figure 5-1. Main Power Fuse Holder

5.2 Cleaning and Replacing the Check Valves

A dirty check valve causes erratic flow rates and pressures. It may also cause the pump to lose prime and/or be difficult to reprime.

1. Turn off the main power switch to ensure you do not unintentionally start the IC25.
2. Release the pressure from the eluent reservoir.
3. Disconnect the tube fittings from the inlet and outlet check valve housings (see Figure 5-2).
4. Use a 12-mm wrench to loosen both check valve housings. Remove the check valve housing from the pump head. Carefully remove the check valve cartridge from the housing.
5. Place the check valve housings and cartridges in a beaker with methanol, and sonicate or agitate for several minutes.

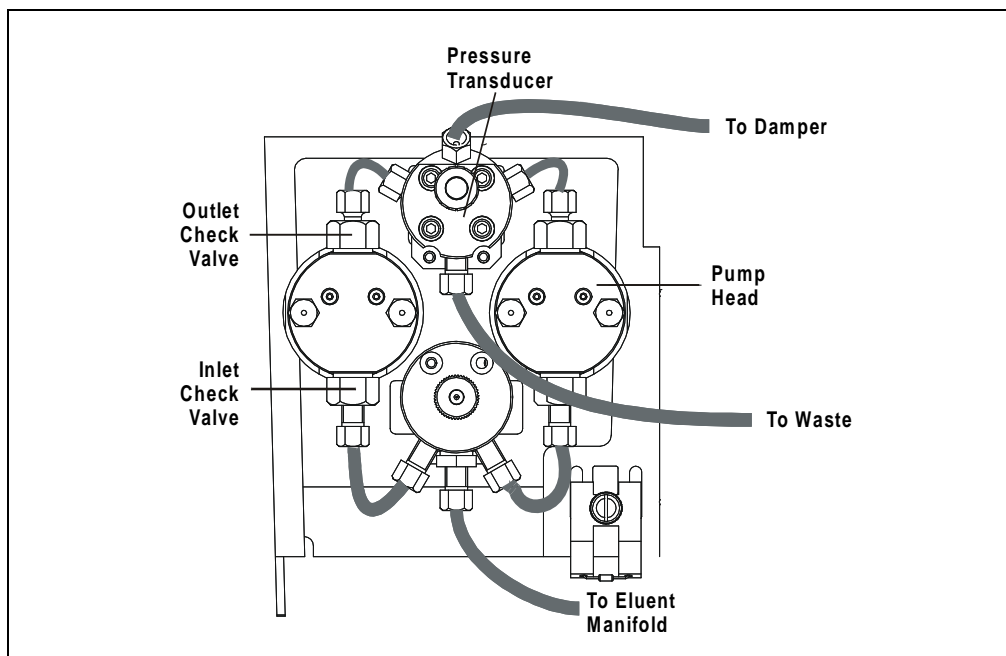

Figure 5-2. Pump Heads and Liquid Lines

6. Rinse each check valve housing and cartridge thoroughly with filtered deionized water.
7. The inlet check valve assembly housing has a 1/4-28 port. Replace the cartridge in the inlet check valve housing; the double-hole end of the cartridge should be visible.

The outlet check valve assembly housing has a 10-32 port. Replace the cartridge in the outlet check valve housing; the single-hole end of the cartridge should be visible. Liquid flows through the check valve in the large single hole and out the small double holes.

IMPORTANT If the cartridge is not oriented correctly, the pump will not operate properly.

8. Reinstall the check valves. Make sure that the inlet check valve is installed on the bottom of the head and that the outlet check valve is installed on the top of the head. Tighten only enough to seat (25 in-lb torque). Tighten a little more only if it leaks.



Overtightening may damage the pump head and the check valve housing and crush the check valve seats.

9. Reconnect the liquid lines. Turn on the main power switch.
10. Prime the pump (see Section B.5). If the pump will not prime and all other possible causes of the problem have been eliminated, replace the check valve cartridge (P/N 047747).
11. After replacing the check valve cartridge, open the **ELAPSED TIME** screen. Move the cursor to the **VALVES IN USE** field and press **Enter** to reset the field to 0 cycles.

5.3 Piston Seal Replacement

A damaged seal allows leakage past the piston and then through the rinse ports in the front of the pump heads. The pump may be difficult to prime, flow rates will be unstable, and baseline noise may be observed.

1. Turn off the main power switch.
2. Disconnect the tube fittings from the pressure transducer and the inlet check valve (see Figure 5-2).
3. Remove the two nuts from the pump head.
4. Carefully disengage the head from the piston by pulling the head straight off and away from its mounting guides.



Lateral motion while disengaging the head from the piston may break the piston.

5. Place the head (front end down) on a clean work surface and lift off the backup washer to expose the piston guide (see Figure 5-3 and Figure 5-4).
6. The pistons are captured by a magnetic retention system and do not come off as part of the pump head assembly. After removing the pump head, apply just enough lateral force to overcome the magnetic field and release the pistons.
7. To remove the piston guide and seal:
 - a. Fill the head cavity with deionized water by injecting through either the piston opening or the inlet check valve.
 - b. Reinsert the piston approximately 1/8 inch into the seal (see Figure 5-4).
 - c. Install a 10-32 fitting plug (P/N 042772) on the outlet check valve and a 1/4-28 fitting plug (P/N 037628) on the inlet check valve. Tighten the plugs.
 - d. Push the piston into the head. This action hydraulically unseats the seal and piston guide from the head. Remove the piston and pull off the guide and seal.
 - e. If the piston guide and seal do not come out, make sure the 10-32 plug is tight. Then, add more water and repeat Steps b and d.
 - f. Remove the 10-32 fitting plug.

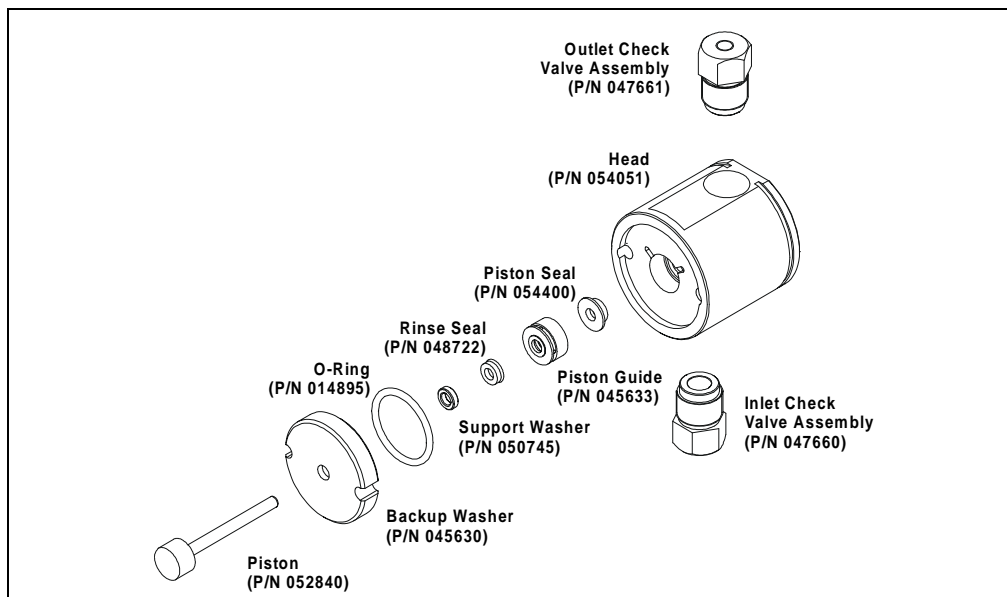

Figure 5-3. Pump Head Assembly

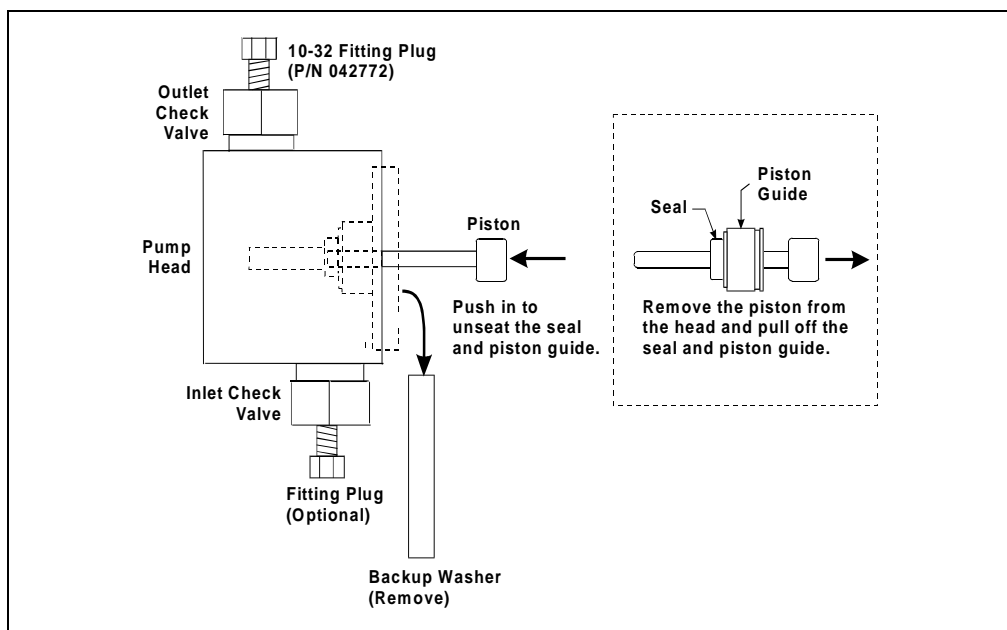

Figure 5-4. Removing the Piston Seal

8. To install the new seal and reinstall the piston guide:
 - a. Push the piston through the piston guide and the new seal. Then insert the piston, piston guide, and seal into the pump head just until the seal makes contact with the bottom of the counterbore (see Figure 5-5, View A).
 - b. Hold the piston guide and seal in place and remove the piston from the head (see Figure 5-5, View B).
 - c. Seat the seal by pushing the piston guide into the head until it is flush with the head.

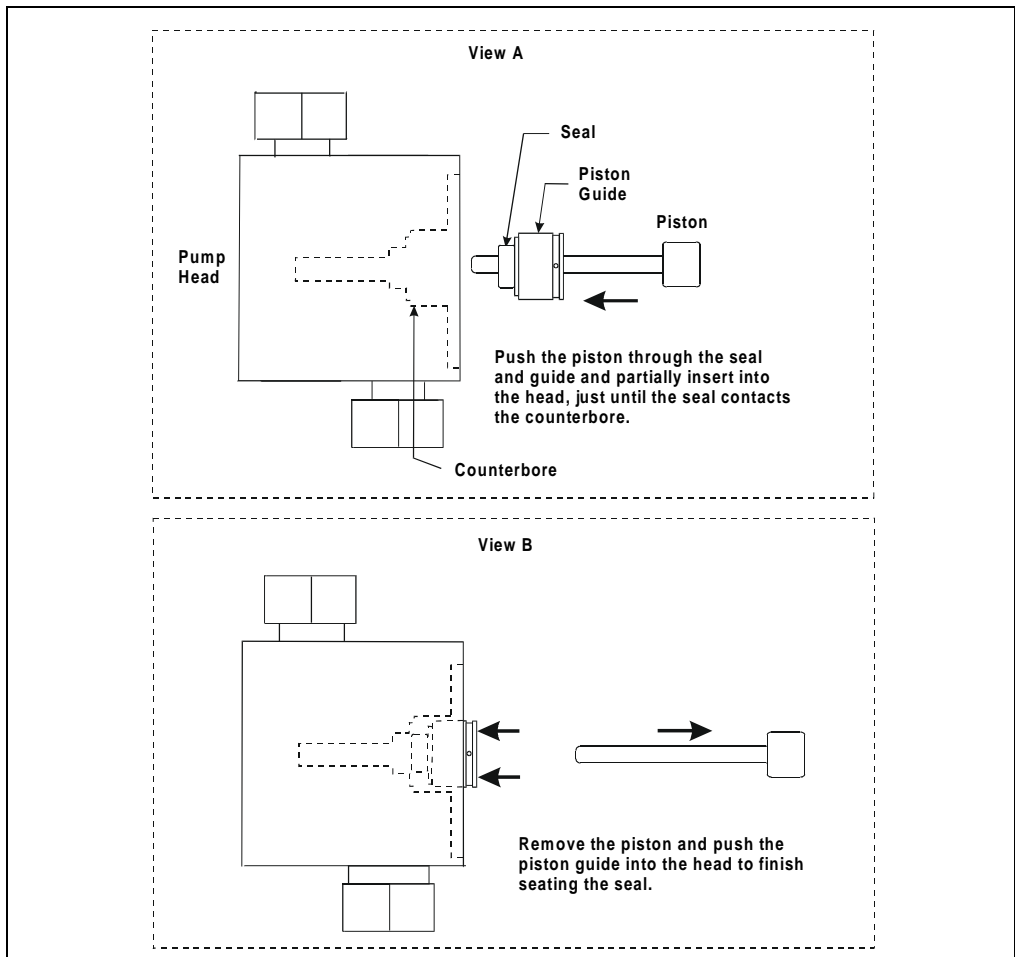

Figure 5-5. Installing the Piston Seal

9. Dionex recommends reinstalling the head and piston as a single assembly so that the piston centers itself. To do this, first press the backup washer into the head until it is flush with the indented surface of the head. Then, insert the piston *halfway* into the head. This ensures that the magnet in the follower picks up the piston. (The follower is the cylinder that holds the piston in place as it moves in and out of the pump head assembly.) Reinstall the head and piston assembly, using a wrench to tighten the nuts evenly (12 in-lb torque).
10. Reconnect the liquid line to the inlet check valve.
11. Reconnect the tube fittings to the pressure transducer.
12. Turn on the main power switch.
13. Open the **ELAPSED TIME** screen. Press **Enter** to reset the **SEALS IN USE** field to 0 cycles. The pump is ready for normal operation.

5.4 Pump Piston Replacement

Continued leaking through the rinse ports after replacing the piston seal (assuming the head is tight) indicates a dirty, scratched, or broken piston.

1. Turn off the main power switch.
2. Disconnect the tube fittings from the pressure transducer and the inlet check valve (see Figure 5-2).
3. Remove the two acorn nuts from the pump head.



CAUTION

Lateral motion while disengaging the head from the piston may break the piston.

4. Slowly pull the head and allow it to separate from the housing. Carefully disengage the head from the piston by pulling the head straight off and away from the mounting guides.
5. The pistons are captured by a magnetic retention system and do not come off as part of the pump head assembly. After removing the pump head, apply just enough lateral force to overcome the magnetic field and release the pistons.
6. If the piston is broken, replace the piston, piston seal, and rinse seal.
7. Dionex recommends reinstalling the head and piston as a single assembly so that the piston centers itself. First, press the backup washer into the head until it is flush with the indented surface of the head. Then, insert the piston *halfway* into the head. This ensures that the magnet in the follower picks up the piston. (The follower is the cylinder that holds the piston in place as it moves in and out of the pump head assembly.) Reinstall the head and piston, using a wrench to tighten the nuts evenly (12 in-lb torque).
8. Reconnect the liquid line to the inlet check valve.
9. Reconnect the tube fittings to the pressure transducer.
10. Turn on the main power switch and prime the pump (see Section B.5).

5.5 Pressure Transducer Waste Valve O-Ring Replacement

A damaged O-ring causes leakage around the base of the pressure transducer waste valve knob.

1. Turn off the main power switch.
2. Remove the valve from the pressure transducer housing by turning the knob counterclockwise until it comes loose from the housing.
3. Remove the O-ring (see Figure 5-6).
4. Carefully slide a new O-ring (P/N 046434) over the end of the valve and push it into the groove.
5. Reinstall the valve in the housing, turning the knob clockwise until the valve is seated.



Do not overtighten the waste valve.

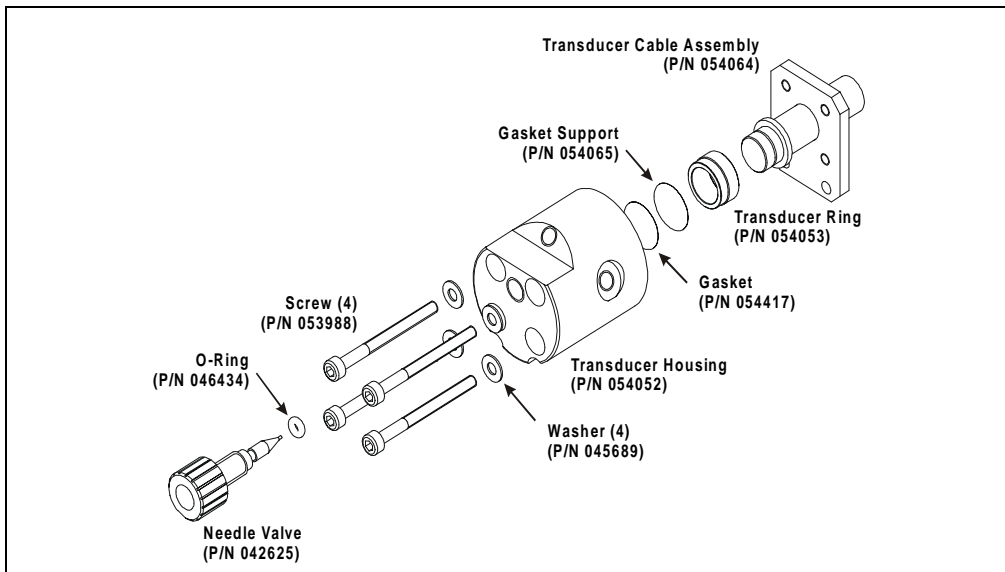

Figure 5-6. Pressure Transducer Assembly

5.6 Eliminating Liquid Leaks

The IC25 is plumbed with 1.60-mm (1/16-in) OD PEEK tubing, ferrule fittings (P/N 043276), and 10-32 fitting bolts (P/N 043275). For tightening requirements, refer to *Installation of Dionex Ferrule Fittings*.

5.7 Removing Trapped Air from the Cell

Air bubbles in the cell can cause pulsations in the baseline, random noise, and low readings. Air may result from outgassing of the eluent. Connecting backpressure tubing to the cell (see below) applies enough backpressure to shrink bubbles and allow them to pass more easily through the cell.

1. Connect a piece of 0.25-mm (0.010-in) ID tubing (P/N 042690), with fittings on both ends, to the cell outlet. The tubing should be no longer than 1 m for 1.0 mL/min and 2 m for 0.5 mL/min.
2. If additional tubing is needed to reach the waste container, use a union (P/N 042627) to adapt to tubing with an ID of 0.5 mm (0.020 in) or larger.

IMPORTANT

The added backpressure must not exceed 0.20 MPa (30 psi). Avoid large increases in flow rate that would result in more than 1.4 MPa (200 psi) being applied to the cell.

5.8 Calibrating the Cell

Every conductivity cell is calibrated before shipment from the factory. The cell calibration constant is recorded on a tag attached to the cell cable. It is also stored in permanent IC25 memory for use when calculating the measured conductivity.

The calibration constant normally remains unchanged, unless the cell is damaged. To check the value entered in memory, open **CELL CALIBRATION** screen. If the cell calibration constant shown on the screen does not match the value recorded on the tag, calibrate the conductivity cell.

- Calibrate the cell to 147.00 $\mu\text{S}/\text{cm}$, using 1 mM KCl. This automatically enters a new value for the cell calibration constant into memory.

To calibrate the cell, follow the procedure below.

1. Connect the pump output line directly to the cell inlet.
2. Pump 0.001 M KCl calibration solution through the cell. Conductivity is slightly flow-rate sensitive, so select the flow rate used for most applications.
3. Set **TEMP COMP** on the **METHOD** screen to 1.7%.
4. Wait until the conductivity reading stabilizes (within 0.1 μS), and then select **CAL** on the **CELL CALIBRATION** screen.
5. After calibration, the conductivity reading should be exactly 147.00 $\mu\text{S}/\text{cm}$. A new value for the cell constant is shown on the **CELL CALIBRATION** screen and entered into memory.
6. Flush the KCl solution from the system by pumping deionized water through the cell lines. When the conductivity reading drops to near zero, stop the pump.
7. Disconnect the pump from the cell.
8. Reconnect the pump to the chromatography module.
9. Reconnect the liquid line from the SRS outlet to the cell inlet.
10. Reset **TEMP COMP** to the optimal value for the eluent.
11. Select a flow rate appropriate for the system in use.

A • Specifications

A.1 Physical

Dimensions 32.8 cm high x 22 cm wide x 41 cm deep
(13.1 in x 8.8 in x 16.4 in)
6 cm (2.4 in) clearance behind the IC25 is required

Weight 20.3 kg (45 lbs)

Decibel Level No more than 60 db (at “A WEIGHING” setting)

A.2 Environmental

Operating Temperature 10 °C to 60 °C (50 °F to 140 °F)

Operating Humidity 5 to 95% relative humidity (noncondensing)

A.3 Electrical

Main Power 100 to 240 Vac, 50/60 Hz. The power supply is auto-sensing and requires no voltage adjustment.

Fuses Two 3.15 amp fast-blow IEC127 fuses (P/N 954745)

A.4 Hydraulics

Pump	Dual-piston, variable speed stroke of 100 μ L; user-selectable constant pressure or constant flow feedback control
Flow Rate	0.04 to 10.0 mL/min, linearly variable in increments of 0.01 mL/min
Operating Pressure	21 MPa (3000 psi) maximum
Pressure Resolution	0.07 MPa (10 psi)
High Pressure Limit	0 to 35 MPa (0 to 5000 psi) in increments of 0.05 MPa (7.25 psi); trips instantaneously
Low Pressure Limit	0 to 35 MPa (0 to 5000 psi) in increments of 0.05 MPa (7.25 psi); trips after a timeout of 0.4 mL
Delay Volume	Approximately 700 μ L

A.5 Conductivity Detector

Range	0.01 μ S to 3000 μ S, full-scale
Temperature Compensation	0.0 to 3.0% per $^{\circ}$ C
Cell Drive	Variable 8 kHz square wave
Control Modes	Local or remote by relay contact-closures or the DX-LAN interface

A.6 Conductivity Cell

Cell Body	PEEK
Active Volume	<1.0 μ L
Maximum Pressure	2.0 MPa (300 psi)
Electrodes	Passivated 316 stainless steel

A.7 SRS Power Supply

Supply Current 50, 100, 300, 500 mA at 1.5 to 7.5 V

Over-Voltage Alarm 8.5 V

Over-Temperature Alarm 40 °C (104 °F)

A.8 Vacuum Degas Assembly (Optional)

Channels Single-channel or dual-channel membrane vacuum degas

Materials Wetted materials, PEEK, PTFE

A.9 Display and Keypad

Display Liquid crystal display with adjustable backlighting

Keypad 28 buttons for entering commands and numeric values

A.10 Method Control

Methods Stores up to 100 separate methods (00 to 99). Each method may contain up to 50 separate steps; the actual number of stored methods depends on the available memory.

Control The keypad is used to select operating parameters and to program methods.

Storage Nonvolatile memory protects against the loss of programs during power-down or in the event of a power failure.

Remote Limited remote operation via TTL-input logic level and TTL-output and relay contact-closures, or full remote programming and control through PeakNet 6 software and the DX-LAN interface.

B.1 Facility Requirements

Make sure the IC25 installation site meets the electrical and environmental specifications listed in Appendix A.

- Install the IC25 on a sturdy workbench with at least 6 cm (2.5 in) free space behind the module for connections and ventilation. Install the IC25 at a height that ensures convenient viewing of the front panel display, as well as access to the interior.



Lift the IC25 only from the bottom or side surfaces. Lifting with the front panel door will damage the door hinges. Use caution when lifting the IC25; it weighs 19 kg (42 lbs).

- Provide a source of helium to pressurize the eluent and regenerant reservoirs, if used. The IC25 is capable of operation without head pressure on the eluents. The eluents must be thoroughly degassed and housed at least 20 cm (8 in) above the IC25, either in an EO1 Eluent Organizer (P/N 044125) or in built-in eluent containment (such as the LC25 Chromatography Oven provides).
- Always filter eluents to remove small particulates that may contaminate the pump. Install an end-line filter (P/N 045987) on the end of each eluent reservoir line. Filters are supplied in the pressurizable reservoir Ship Kits. Refer to the *Pressurizable Reservoir Installation Instructions* for details.

B.2 Rear Panel Connections

B.2.1 Power Connection

Connect a modular power cord (IEC 320 C13) from the main power receptacle on the IC25 rear panel (see Figure B-1) to a grounded, single-phase power source.



SHOCK HAZARD—To avoid electrical shock, a grounded receptacle is required. Do not operate or connect to AC power mains without an earthed ground connection.



Operation at AC input levels outside the specified operating voltage range may damage the IC25.



The power supply cord is used as the main disconnect device. Make sure the socket-outlet is located near the IC25 and is easily accessible.

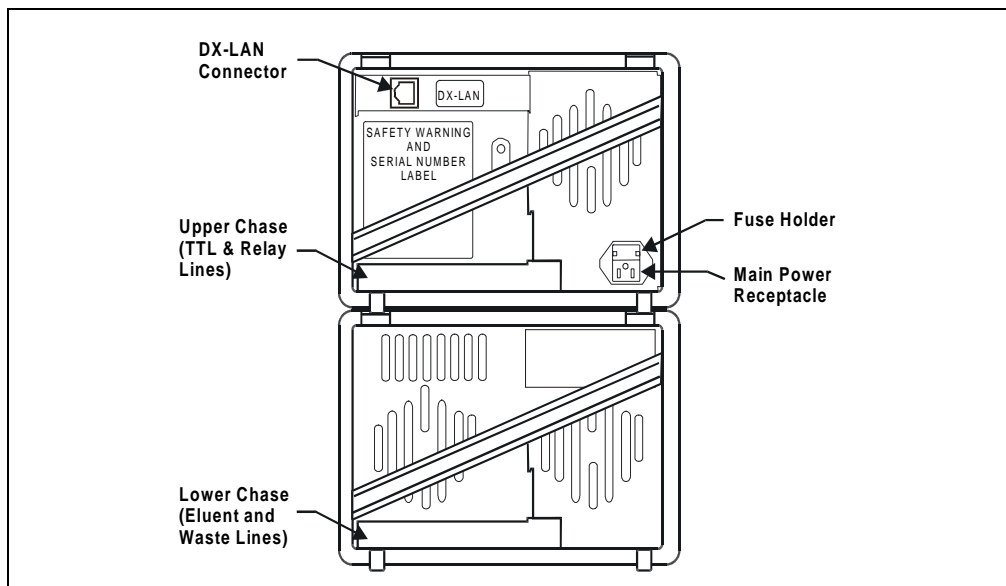

Figure B-1. IC25 Rear Panel

B.2.2 Waste Lines

There are two IC25 waste lines: one from the pressure transducer assembly and one from the leak drain. The waste lines are installed at the factory and then routed to the rear panel.

Place the free ends of the waste lines into a single waste container positioned below the level of the IC25. This will maintain a positive siphon (see Figure B-2).

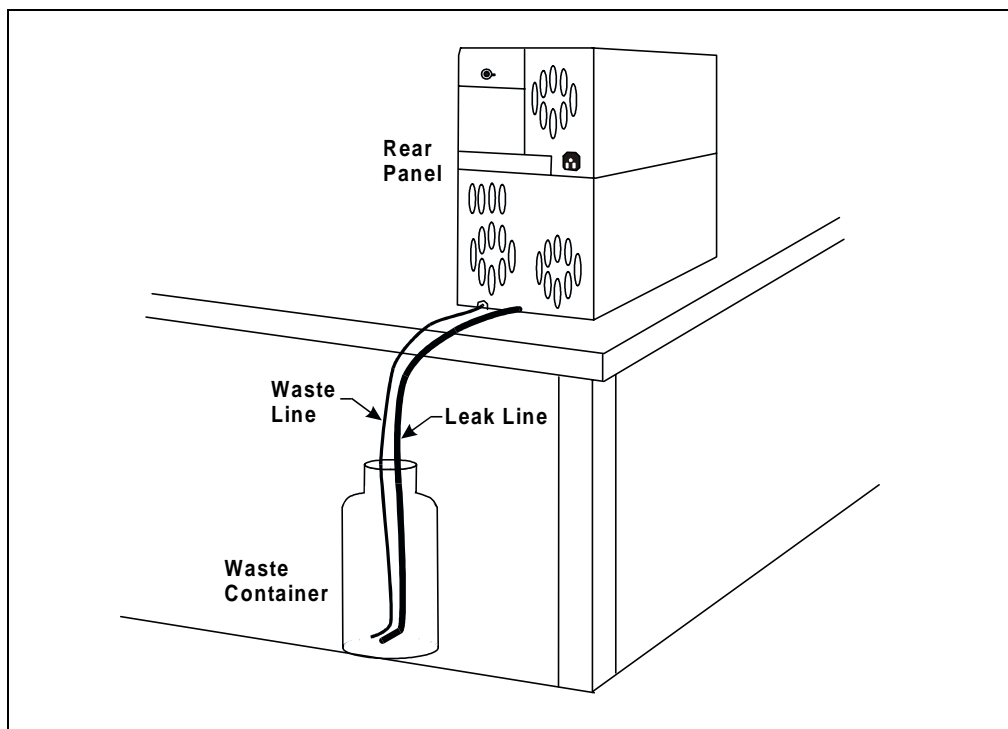

Figure B-2. Eluent Waste Lines

B.2.3 DX-LAN Interface: 10BASE-T Connections (Optional)

NOTE There are two types of DX-LAN connectors. Before proceeding, check the IC25 rear panel. If a DX-LAN 10BASE-T RJ-45 (telephone-style) connector is installed, follow the interface instructions in Section B.2.3. However, if a DX-LAN 10BASE-2 BNC connector is installed, follow the interface instructions in Section B.2.4.

In order to communicate with a host computer running Dionex chromatography software, the IC25 must contain a detector interface card (P/N 056798) and an unshielded twisted-pair DX-LAN cable (P/N 960281) must be connected from the RJ-45 (10BASE-T) connector on the rear panel to a “combo” 10BASE-T Ethernet hub (P/N 056909).

Installing or Replacing the Detector Interface Card

NOTE If the DX-LAN option was not installed at the factory, order the detector interface card kit (P/N 057007). The kit includes all the components required for DX-LAN communication.



STATIC—The IC25 electronics cannot be serviced by the user. The detector interface card must be installed by qualified personnel. Standard anti-static procedures must be observed when installing the interface card or handling the CPU card.



To prevent damage to the IC25, turn off the main power before installing the detector interface card. After confirming that the LED on the CPU card is off (not green or red), unplug the power. Do not rely on the front panel power switch.

1. To replace an existing detector interface card, remove the DX-LAN cable from the 10BASE-T connector on the IC25 rear panel (see Figure B-1).
2. Remove any TTL/Relay plugs from the connectors at slot 4 of the electronics chassis (see Figure 2-5).

3. Disconnect the 60-pin ribbon cable from the inside of the front panel by opening the ejector latches on the connector.
4. Using a screwdriver as a lever, open the white ejector latch at the bottom of the CPU card. Remove the CPU card, cable, and Relay card as a single unit.
5. Remove the detector interface card (if present) from slot 4 of the electronics chassis.
6. Insert the new detector interface card (P/N 056798) into slot 4:
 - a. Slide the card to the rear.
 - b. Verify that the 10BASE-T connector is aligned with the opening at the rear and that the card is aligned with the card connector.
 - c. Press firmly on the card until it mates fully with the connector on the rear panel. Pull on the card to verify that it cannot move.
7. Reinstall the CPU/Relay card. Press firmly until the card is inserted into the connector on the rear panel.
8. Reconnect the ribbon cable to the 60-pin connector on the inside of the front panel. The header and connector are key-polarized near the center. The ejector latches should be partially open to accept the cable connector.
9. Install the 10BASE-T DX-LAN cable (see the following section).

Installing the 10BASE-T DX-LAN Cable

1. Install the “combo” 10BASE-T Ethernet hub (P/N 056909) on a workbench or on the wall. For installation instructions and site requirements, refer to the installation guide shipped with the hub.
2. Plug the 10BASE-T DX-LAN cable (P/N 960281) into a 10BASE-T port on the front panel of the hub.

The 10BASE-T DX-LAN cable is a Category 5 unshielded twisted-pair cable. Do not substitute a cable of an inferior grade. Failure to use the correct cable will cause the detector to lose communication with the host computer.

IMPORTANT

3. Connect the other end of the cable into the 10BASE-T DX-LAN connector on the IC25 rear panel (see Figure B-1).

4. Connect a 10BASE-T cable (P/N 960281) from a 10BASE-T port on the hub to the 10BASE-T port on the host computer's internal DX-LAN card. If the connection is via port 8 on the hub, set the Normal/Uplink push button to Normal.

NOTE Installation instructions for the host computer's internal DX-LAN card are in *Installing the Dionex PeakNet 6 System* (Document No. 031631).

IMPORTANT

When using 10BASE-T cabling, you must use a hub. If you simply plug the 10BASE-T cable from the detector into the connector on the host computer's DX-LAN card, the connection will either not work or will be unreliable.

Network Upgrades

If you upgrade the network from a BNC connector to a 10BASE-T connector, turn off the computer power briefly and then turn it on again to allow the host computer's internal Ethernet DX-LAN card to detect the 10BASE-T connector. The Ethernet card searches for the type of installed cabling only at power-up.

Cascading Hubs

Cascading, or connecting hubs together through their 10BASE-T ports, increases the number of ports or the number of users supported on the network. For instructions, refer to the installation guide for the hub.

B.2.4 DX-LAN Interface: BNC Connections (Optional)

NOTE There are two types of DX-LAN connectors. Before proceeding, check the IC25 rear panel. If a DX-LAN 10BASE-2 BNC connector is installed, follow the interface instructions in Section B.2.4. However, if a DX-LAN 10BASE-T RJ-45 (telephone-style) connector is installed, go on to Section B.2.3.

In order to communicate with a host computer running Dionex chromatography software, the IC25 must contain a detector interface card (P/N 046341) and a coaxial DX-LAN cable (P/N 960405) must be connected to the BNC tee connector (P/N 921914) on the rear panel. From the IC25, connect the DX-LAN cable to one of the following:

- Another instrument equipped with a BNC connector, *or*
- A “combo” 10BASE-T Ethernet hub (P/N 056909). The hub has one BNC port and eight 10BASE-T (RJ-45) ports.

Installing or Replacing the Detector Interface Card

NOTE If the DX-LAN option was not installed at the factory, order the detector interface card kit (P/N 044195). The kit includes the components required for DX-LAN communication.



STATIC—The IC25 electronics cannot be serviced by the user. The detector interface card must be installed by qualified personnel. Standard anti-static procedures must be observed when installing the interface card or handling the CPU card.



To prevent damage to the IC25, turn off the main power before installing the detector interface card. After confirming that the LED on the CPU card is off (not green or red), unplug the power. Do not rely on the front panel power switch.

1. To replace an existing detector interface card, remove the hex nut securing the DX-LAN BNC connector to the IC25 rear panel (see Figure B-1).

2. Remove any TTL/Relay plugs from the connectors at slot 4 of the electronics chassis (see Figure 2-5).
3. Disconnect the 60-pin ribbon cable from the inside of the front panel by opening the ejector latches on the connector.
4. Using a screwdriver as a lever, open the white ejector latch at the bottom of the CPU card. Remove the CPU card, cable, and Relay card as a single unit.
5. Remove the detector interface card (if present) from slot 4 of the electronics chassis.
6. Insert the new detector interface card (P/N 046341) into slot 4:
 - a. Slide the card to the rear.
 - b. Verify that the BNC connector is aligned with the opening at the rear and that the card is aligned with the card connector.
 - c. Press firmly on the card until it mates fully with the connector on the rear panel. Pull on the card to verify that it cannot move.
7. Reinstall the CPU/Relay card. Press firmly until the card is inserted into the connector on the rear panel.
8. Reconnect the ribbon cable to the 60-pin connector on the inside of the front panel. The header and connector are key-polarized near the center. The ejector latches must be partially open to accept the cable connector.
9. Install the hex nut, BNC tee connector, and coaxial DX-LAN cable (see the following section).

Installing the BNC Tee Connector and Coaxial DX-LAN Cable

1. Install the BNC tee connector (P/N 921914):
 - a. Note the two small locking pins on either side of the DX-LAN BNC connector on the rear panel (see Figure B-1).
 - b. Push the tee connector onto the BNC connector on the rear panel and twist until the locking pins are fully engaged in the slots on the tee connector.
 - c. Pull firmly on the tee connector to verify that it cannot move.
2. Install the coaxial DX-LAN cable (P/N 960405):

- a. Push the metal sleeve on the end of the DX-LAN cable onto one port of the BNC tee connector.
- b. Twist the metal sleeve until the locking pins on the tee are fully engaged in the slots on the cable's metal sleeve.
- c. Pull the end of the cable to verify that it cannot move.

The DX-LAN cable (P/N 960405) is a 50 ohm coaxial impedance cable. (Fifty ohm cables are imprinted with “RG-58U.”) Do not substitute cables. Failure to use the correct cable or to lock it into place on the BNC connector will cause the IC25 to lose communication with the host computer.

IMPORTANT

3. If the IC25 is the last module in the network to be connected, install a terminator resistor plug (P/N 921034) on the remaining port of the BNC tee connector. (These terminator resistor plugs are shipped with Dionex chromatography software.)

If the IC25 is not the last module in the network, connect the cable from the next module to the BNC tee.

4. Plug the free end of the coaxial DX-LAN cable into one of these:
 - The BNC connector on another instrument, *or*
 - The BNC port on the rear panel of the “combo” 10BASE-T Ethernet hub (P/N 056909).

If the connection terminates at the hub, install a BNC terminator (included with the hub) on the BNC tee connector.

50 Ohm terminator resistor plugs must be installed at each end of the DX-LAN network. Before beginning operation, verify that both ends of the DX-LAN have terminator resistor plugs installed.

IMPORTANT

B.3 Electronics Chassis Connections

1. Route the cable from the injection valve through the IC25 upper chase and connect the cable to the **LC VALVE** connector in slot 1.
2. Route the cable from the SRS through the IC25 upper chase and connect the cable to the **SRS** connector in slot 2.

NOTE Refer to Appendix D for TTL and relay installation instructions.

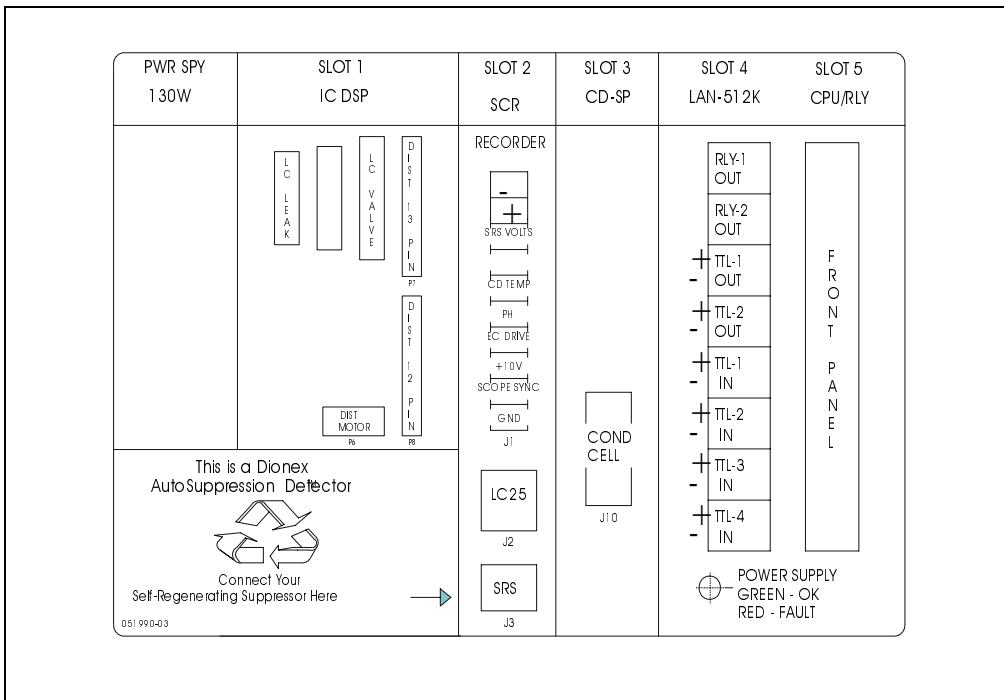

*Figure B-3. IC25 Electronics Chassis
(Located behind upper door)*

B.4 Eluent Reservoir Connections

B.4.1 Eluent Inlet Line Connection

Before shipment from the factory, the eluent inlet lines are connected to the eluent selection valve.

B.4.2 Eluent Outlet Line Connection

1. Route the eluent outlet line exiting the pump pressure transducer through the slot on the left side of the IC25 and connect it to the injection valve.

It is important to minimize the volume between the pump and the injection valve. If possible, after determining the relative positions of all system components, shorten the eluent line.

2. Untape the inlet lines from the rear panel and connect them to the eluent reservoirs. The standard IC25 includes one eluent inlet line; the IC25 with the vacuum degas option has two lines, labeled “A” and “B.” If desired, label each eluent reservoir with the letter of the fitting it is connected to.

NOTE If an eluent channel will not be used, install a 1/4-28 plug (P/N 037628) in its fitting. This will improve the degas performance of the channel in use.

If spare parts are needed, order the following: eluent line “A” (P/N 047694) and/or eluent line “B” (P/N 047695).

3. If the eluent reservoirs are going to be pressurized, verify that a regulator (P/N 051997) is installed on the gas supply line to the reservoir. Turn on the gas supply and adjust the pressure to 55 KPa (8 psi).

If the eluent reservoirs are not pressurized, vent the bottles by loosening the reservoir cap or by removing the plug from the cap.



Never pressurize the reservoirs above 69 KPa (10 psi).

B.5 Priming the Pump

Three priming procedures are described below:

- Priming using the priming block
- Priming using the **PRIME** button on the IC25 front panel
- Priming the pump heads with Isopropyl alcohol

NOTE Prime the pump heads with alcohol only if the other two procedures are ineffective.

B.5.1 Priming Using the Priming Block

1. Open the **MAIN** screen and select **LOCAL** mode and **DIRECT CNTRL.**
2. Move the cursor to the desired eluent. Enter 100 to select 100% of that eluent and press **Enter** or a cursor arrow button. This automatically sets the other eluent to 0%.
3. Connect a 10 mL syringe (P/N 054578) to the luer port in the priming block. Turn the priming block valve counterclockwise one turn (see Figure B-4).

NOTE If the eluent is pressurized, liquid will flow into the syringe as soon as you open the valve.

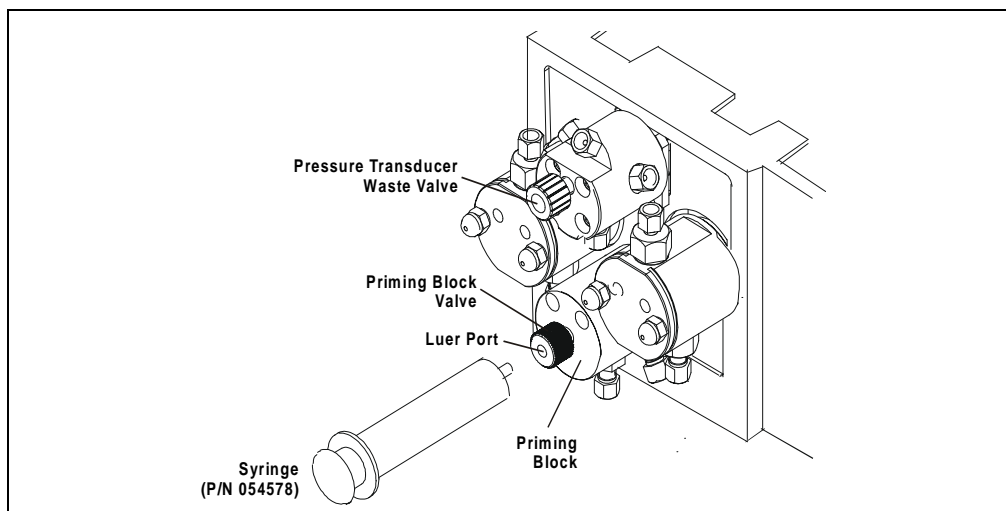

Figure B-4. Priming the Pump

4. Turn on the pump.
5. If the eluent is not pressurized, be sure that there is a vent from the eluent bottle or loosen the bottle caps. Draw the syringe back to pull eluent through the flow path. It may take several syringe draws to remove all air or previous eluents from the tubing. If the IC25 includes a vacuum degas pump, draw an additional 17 mL of eluent through the priming block.
6. Return to Step 2. Select the other eluent and repeat the priming procedure. Press **Prime** again to return the flow to the set flow rate.
7. When the pump has been primed thoroughly, turn the priming block valve counterclockwise until closed (see Figure B-4). Do not overtighten.

B.5.2 Priming Using the Prime Button

1. Open the **MAIN** screen and select **DIRECT CNTRL** and **LOCAL**.
2. Set the eluent to 100% of the line to be primed. Press **Enter** or a cursor arrow button.
3. Open the pressure transducer waste valve one to two turns counterclockwise. This directs the eluent flow path to waste and eliminates backpressure.
4. Press **Prime** on the IC25 front panel. The pump will pump at 9.9 mL/min for a standard bore pump and 2.5 mL/min for a microbore pump.

NOTE If the vacuum degas pump is installed, pump an additional 17 mL of eluent through the pump.

5. Allow the pump to prime until all air and previous eluents are purged and no air bubbles can be seen exiting the waste line. If the eluent manifold has not been primed, allow several extra minutes for the eluent to pass through the pump.
6. Press **Prime** again to return the flow to the set flow rate.
7. Close the pressure transducer waste valve. The pump is now ready for operation.

B.5.3 Priming the Pump Heads with Isopropyl Alcohol

NOTE Prime the pump heads with alcohol only if the procedure described in Section B.5.1 and Section B.5.2 are ineffective.

1. Connect a 10 mL syringe (P/N 054578) to the luer port on the priming block (see Figure B-4).
2. Open the pressure transducer waste valve (see Figure B-4) by turning the knob counterclockwise about two turns.
3. Turn the priming block valve counterclockwise about two turns.
4. Turn on the pump.
5. Use the syringe to slowly push alcohol through the pump. Avoid pushing any air trapped in the syringe through the pump, as this will result in loss of prime. Verify that alcohol with no trapped bubbles is traveling down the waste line from the transducer.
6. Continue pushing on the syringe until you have closed the priming block valve. Do not overtighten. Disconnect the syringe from the priming block. The pressure transducer waste valve should remain open.
7. Press **Prime** to purge the alcohol from the pump heads and flush the heads with the desired eluent.



Alcohol may damage some columns. Be sure to rinse the alcohol from the pump, using the process described above.

8. Close the pressure transducer waste valve. The pump is now ready for operation.

B.6 Automatic SRS Power Control (Optional)

TTL connections can be used to automatically switch off the power to the Self-Regenerating Suppressor (SRS). When the IC25 is set up for this option, a TTL signal is sent to the IC25 when the pump flow stops and then, 5 minutes later, the IC25 will turn off the SRS power. The 5-minute delay allows momentary flow interruptions without disturbing the SRS.

1. Open the **PUMP OPTIONS** screen (see Section C.1.5) and set **TTL2 OUTPUT USAGE** to **0 FLOW**.
2. Open the **TIME FUNCTION IN** screen and assign TTL3 to **PUMP/SRS ON/OFF**. Select the **NORMAL EDGE** mode.
3. Locate a pair of twisted black and red wires (P/N 043598) and two green TTL connector plugs (P/N 921019) in the IC25 Ship Kit.
4. Insert the wires into the plugs, with the signal wire (red) on top and the ground wire (black) on the bottom.
5. Plug one end of the cable into **TTL2 OUT** on the IC25 (see Figure B-5). Plug the other end of the cable into **TTL3 IN**.

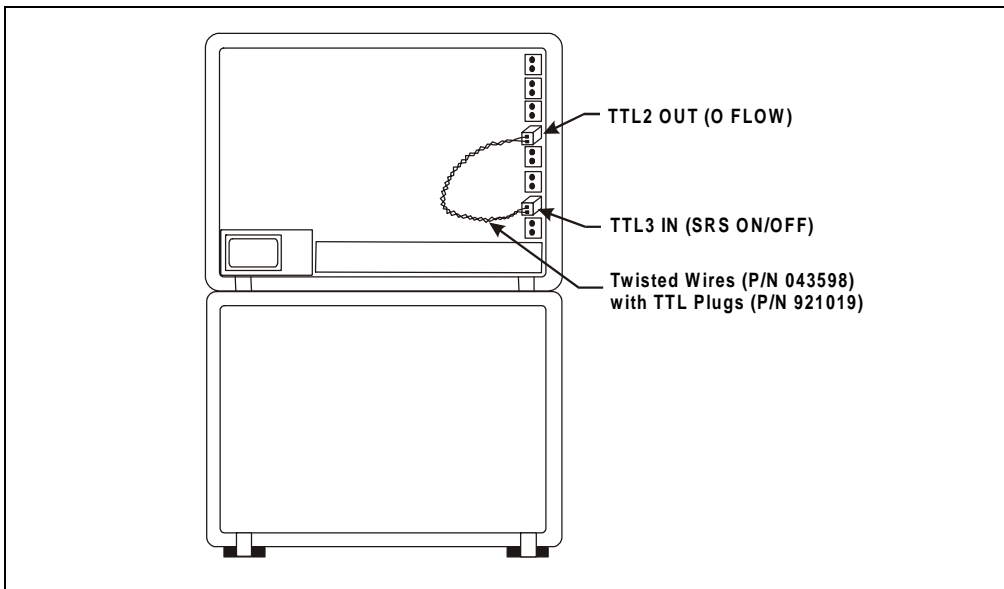

Figure B-5. TTL Connections for SRS Power Control
(IC25 Front View without Upper Door)

C • User Interface

This appendix illustrates and describes all of the screens that can be displayed from the front panel of the IC25 Ion Chromatograph. There are four types of screens (see Figure C-1):

- **Operational** screens are used to create, edit, and run the methods that control IC25 operation.
- **Setup** screens are used to select default system parameters.
- **Diagnostic** screens provide access to IC25 diagnostic information and tests.
- **Calibration** screens provide a way to calibrate various IC25 functions; for example, the flow rate and pressure offset.

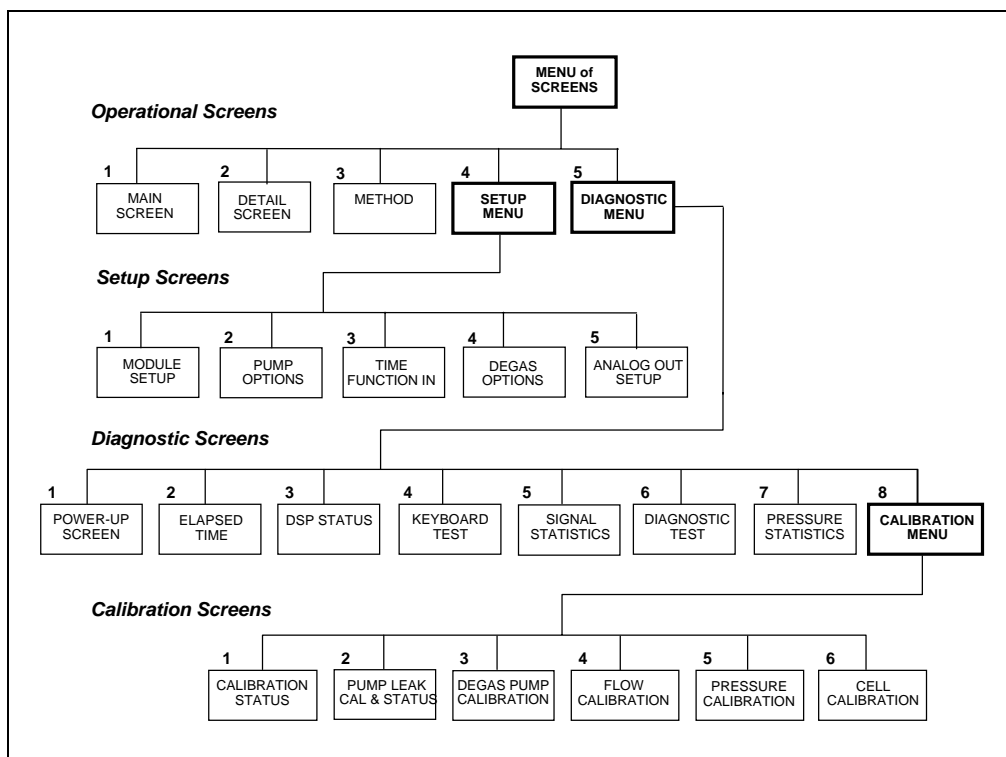

Figure C-1. IC25 Menu Structure

Menu of Screens

This screen provides top-level access to the IC25 operational screens and the **DIAGNOSTIC MENU**. It is displayed when **MAIN** is pressed.

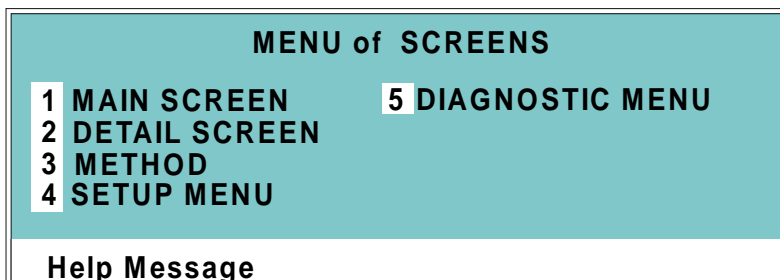

Figure C-2. Menu of Screens

There are two ways to select a screen from a menu:

- Press the number button on the keypad that corresponds to the menu option. For example, on the **MENU of SCREENS**, press **4** from anywhere on the screen to display the **SETUP MENU**.
- Move the cursor to the field containing the screen number and press **Enter**.

To display a brief description of each screen, press **Help**.

C.1 Operational Screens

C.1.1 Main Screen

Use the **MAIN** screen to select the mode of operation, the method number to run (when using Method control), and basic operating parameters (when using Direct control).

Active data is displayed on the screen in large characters.

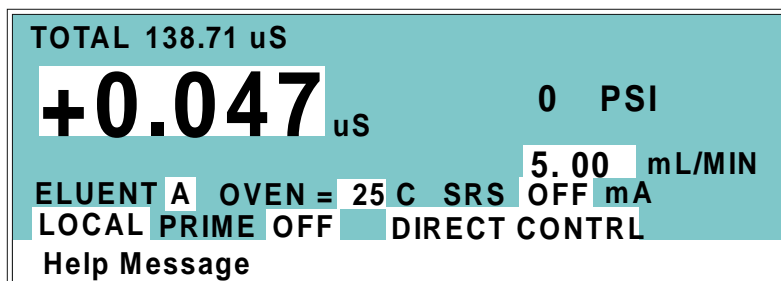

Figure C-3. Main Screen

Field	Description
TOTAL	Displays total conductivity (without an offset).
PSI (MPa, BAR)	Displays the system backpressure in psi, MPa, or bar. Set the unit of measure from the PUMP OPTIONS screen.
mL/MIN	Displays the eluent flow rate in milliliters per minute. In Direct control, set the flow rate in this field, also. The flow rate is programmed in the Method when using Method control.
ELUENT	Selects eluent A or B.
OVEN	Sets the temperature of the LC25 Chromatography Oven.
SRS	Selects the amount of current sent to the Self-Regenerating Suppressor. The discrete settings are Off, 50, 100, 300, and 500 mA. Current selection depends on the eluent concentration, flow rate, etc.

Field	Description
LOCAL/ REMOTE	Local mode is used for front panel control. The IC25 will automatically switch to Locked Remote mode when a Connect command is given from PeakNet 6. Locked Remote mode prevents operation from the keypad. The Locked Remote mode can be canceled only by a Disconnect command from PeakNet 6 or by turning off the IC25 and then turning it back on. Note: PeakNet 6 does not use the regular (unlocked) Remote mode.
PRIME	Turns the pump priming ON or OFF .
DIRECT CONTROL/ METHOD	Press either Select button to toggle between the Direct Control and Method operating modes.

C.1.2 Detail Screen

Use the **DETAIL** screen to set various IC25 operating parameters and to view the current settings for other operating parameters. Refer to the **MAIN** screen (see Section C.1.1) for a description of fields that are common to both screens.

0 PSI	OUTPUT	0.05 uS	TTL1	0
5.00 mL/MIN	OFFSET	189.13 uS	TTL2	0
LOAD	TOTAL	189.18 uS	RLY1	0
SRS OFF mA	RANGE	100 uS	RLY2	0
TEMP COMP 1.7	OVEN TEMP	25 C	READY	
LIMIT 0- 5000 PSI	P-POINT	L= 0 R= 0		
LOCAL	DIRECT CONTRL			
Help Message				

Figure C-4. Detail Screen

Field	Description
LOAD/INJECT (Valve position)	Sets the position of the injection valve to INJECT or LOAD .
TEMP COMP	Sets the temperature compensation factor. The range is 0 to 3%. 1.7% is appropriate for most eluents.
LIMIT	The pressure limit range value in psi, MPa, or bar.
P-POINT	Reports the current pressurization point for the left and right pump pistons.
OUTPUT	Displays the conductivity, corrected by the offset.
OFFSET	Displays the conductivity value used to correct the output. The conductivity can be offset by pressing the front panel button or by programming the command into a Method.
RANGE	Sets the analog output range. Select a range between 0.01 and 3000 μ S.
TTL1	Provides TTL control of accessories. In a method, these values occur according to the method timing. In Direct control, select off (0) or on (1).
TTL2	

IC25 Ion Chromatograph

Field	Description
RLY1	Provides relay contact closure control of accessories. In a method, these values occur according to the method timing. In Direct control, select off (0) or on (1).
RLY2	

C.1.3 Method Screen

Select, edit, and save methods from the **METHOD** screen.

NOTE The **TEMP COMP**, **OVEN TEMP**, and **SRS** fields are not time-programmable.

METHOD EDIT		1	SAVE TO		1	RUN		1
TEMP COMP		1.7	OVEN TEMP		25	SRS		OFF
TIME	V	ELU	RANGE	OFFSET	MARK	FLOW		
INIT	L	A	100 uS	*		1.00	>	
0.00							>	
1.00	L	A	200 uS		*	1.01	>	
2.00	L	A	300 uS	*	*	1.02	>	
Help Message								

Figure C-5. Method Screen

Field	Description
METHOD EDIT	The method number (0 through 99) to edit.
SAVE TO	The method number (0 through 99) the current method will be saved to. This may be either the edit number or a different number.
RUN	The method number (0 through 99) to run. Entering a method number here does not affect the status of the method clock. The Run Method button on the front panel keypad controls the clock.
TEMP COMP	Sets the temperature compensation factor. The range is 0 to 3%; 1.7 is appropriate for most eluents.
OVEN TEMP	Selects the temperature of the LC25 Chromatography Oven.
SRS	Selects the amount of current sent to the Self-Regenerating Suppressor. The discrete settings are Off, 50, 100, 300, and 500 mA. Current selection depends on the eluent concentration, flow rate, etc.

Field	Description
TIME	The elapsed time for each method step. Every method must begin with the INIT (initial) step, followed by the TIME0.00 step. Each additional entry under TIME indicates the elapsed time at which the specified conditions (valve position, flow rate, etc.) occur.
V	Sets the position of the injection valve to INJECT or LOAD .
ELU	Selects eluent A or B.
RANGE	Sets the analog output range. Select a range between 0.01 and 3000 μ S.
OFFSET	Stores the offset value. The baseline is set by subtracting the offset measured when this step is executed from all subsequent measurements. An asterisk (*) indicates that offset will occur at this time.
FLOW	The flow rate through the pump, in milliliters per minute.
MARK	Sends a positive pulse to the analog output (recorder) as an event marker. An asterisk (*) indicates that a mark will occur at this time.
v	A small “v” adjacent to the bottommost time entry indicates that there are additional lines below the last line in the screen. Use the arrow buttons to scroll down to the additional lines.
^	A caret (^) adjacent to the topmost time entry indicates that there are additional lines above the top line. The caret displays only when the screen is scrolled down additional lines. Use the arrow buttons to scroll up to the additional lines.

C.1.4 Module Setup

Select miscellaneous settings from this screen. These remain the default settings for the IC25 until new selections are made.

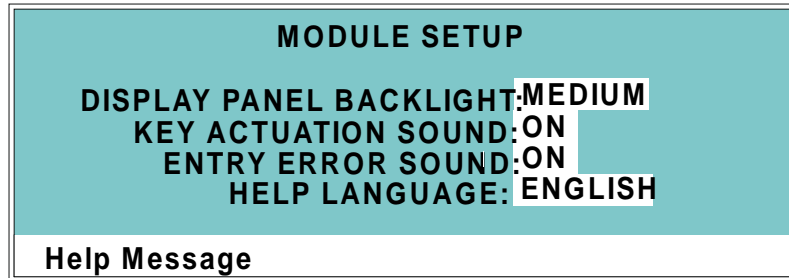

Figure C-6. Module Setup Screen

Field	Description
DISPLAY PANEL BACKLIGHT	Sets the backlight to LOW, MEDIUM, HIGH , or OFF .
KEY ACTUATION SOUND	Toggles the key actuation sound ON or OFF .
ENTRY ERROR SOUND	Toggles the error entry sound ON or OFF .
HELP LANGUAGE	Selects the language for on-screen Help messages.

NOTE If no keypad buttons are pressed within a two-hour period, the backlight automatically turns off. To turn the backlight on again, press any keypad button. Press the button a second time to activate its function.

C.1.5 Pump Options

Use this screen to view the type of pump head installed and to set pump operation parameters.

PUMP OPTIONS

PUMP HEAD MATERIAL: INERT

PUMP HEAD VOLUME: 100 μ L

CONTROL MODE: PRESSURE

TTL2 OUTPUT USAGE: 0 FLOW

PRESSURE UNITS: PSI

Help Message

Figure C-7. Pump Options Screen

Field	Description
PUMP HEAD MATERIAL	Reports the head material, INERT (for PEEK heads). This parameter cannot be changed.
PUMP HEAD VOLUME	Reports the head volume, 100 μ L. This parameter cannot be changed.
CONTROL MODE	Sets the pump flow control mode to PRESSURE or FLOW . Pressure mode uses pressure as the primary source of feedback to maintain flow rate stability. Flow mode uses motor speed as the primary source of feedback to maintain stability.
TTL2 OUTPUT USAGE	Selects the active state of the TTL2 output signal. Select 0 FLOW or NORMAL . To automatically switch off the power to a Self-Regenerating Suppressor when the pump flow stops, select the 0 FLOW option and connect TTL2 out on the pump to TTL3 in on the detector (see Section B.6 for detailed connection instructions). Select NORMAL to activate TTL2 as a standard TTL.
PRESSURE UNITS	Selects the unit of measure for pressure (PSI , MPa , or BAR).

C.1.6 Time Function In

This screen displays functions that can be controlled by a TTL input from another device. Four input TTL controls may be assigned to the time input functions. Control is enabled when Local mode is selected.

Use the **Select** buttons to assign TTL1 through TTL4 to any four of seven IC25 functions. The default assignments are shown in Figure C-8.

TIME FUNCTION IN	MODE:	NORMAL	EDGE
PUMP/SRS ON/OFF:		TTL1	
RUN METHOD:		TTL2	
OFFSET:		TTL3	
METHOD NUMBER INCR:		TTL4	DECR: TTL <input type="checkbox"/>
MARK:		TTL	(OUT)
RANGE X10:		TTL	<input type="checkbox"/>
Help Message			

Figure C-8. Time Function In Screen

Field	Description
MODE	<p>The MODE field determines the type of input signal the IC25 responds to. Select NORMAL EDGE, INVERTED EDGE, NORMAL PULSE, or INVERTED PULSE. Normal edge, the default, is compatible with the TTL output signals provided by Dionex modules.</p> <p>The signal type can be changed to match the signal of the controlling device; see Appendix D for details.</p>

C.1.7 Degas Options

Use this screen to set the cycle duration and frequency for the optional degas pump.

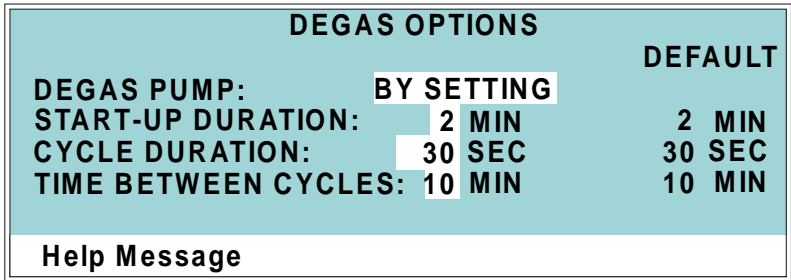

Figure C-9. Degas Options Screen

Field	Description
DEGAS PUMP	<p>Selects one of the following operating options:</p> <ul style="list-style-type: none"> • BY SETTING: The degas pump runs according to the selected degas options. • MONITOR: The IC25 checks the degas vacuum reading once a minute. If the reading falls 500 counts below the calibration threshold value (shown on the DEGAS PUMP CALIBRATION screen), the degas pump turns on for the cycle duration time. • ALWAYS OFF: The degas pump is always off. • ALWAYS ON: The degas pump is always on. This setting is used for testing the pump during servicing.
START-UP DURATION	For how long the degas pump runs at power-up (2 to 5min).
CYCLE DURATION	For how long the degas pump runs during each cycle (0 to 120 sec).
TIME BETWEEN CYCLES	The elapsed time between cycles (1 to 99 min).

The IC25 monitors the degas vacuum reading once a minute. If the degas vacuum reading is 2000 or more lower than the degas calibration value, the following error message is displayed:

```
LOW VACUUM ALARM!!  
Check DEGAS OPTIONS settings or refer to  
service manual
```

If this occurs, try increasing the **CYCLE DURATION** time and/or decreasing the **TIME BETWEEN CYCLES**. If adjusting these settings does not solve the problem, contact Dionex.

C.1.8 Analog Out Setup

Use the **ANALOG OUT SETUP** screen to set parameters for the analog output, such as for a recorder or oscilloscope.

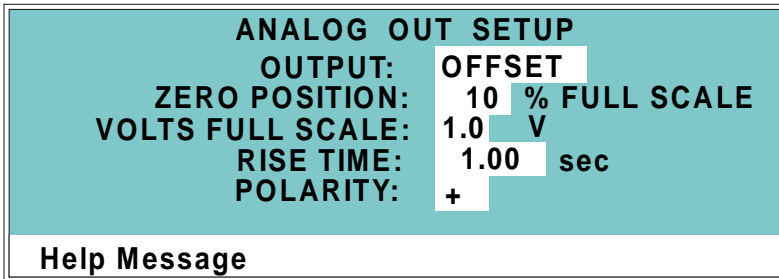

Figure C-10. Analog Out Setup Screen

Field	Description
OUTPUT	Sets the analog output to one of the following: <ul style="list-style-type: none"> • OFFSET uses the offset level value. • TOTAL uses the total cell conductivity, charge, or current, disabling the offset function. • ZERO sets the output to zero volts. • FULL SCALE sets the output to the full-scale setting.
ZERO POSITION	Sets the analog (recorder) offset level (0 to 100%).
VOLTS FULL SCALE	Sets the full-scale voltage for a signal equal to the range setting. The discrete settings are 1.0, 0.1, and 0.01 volt.
RISE TIME	Sets the output filter rise time to 0.05, 0.1, 0.2, 0.5, 1.0, 2.0, 5.0, or 10.0 seconds. Rise time is a measure of how quickly the detector goes from 10% to 90% of step input changes.
POLARITY	Determines the output voltage polarity. The output is usually set to positive polarity. Select negative polarity to reverse peaks from indirect detection.

C.2 Diagnostic Screens

To access the IC25 diagnostics, select the **DIAGNOSTIC MENU** from the **MENU of SCREENS**.

When a diagnostic screen is displayed, pressing **Menu** opens the **DIAGNOSTIC MENU**. When the **DIAGNOSTIC MENU** is displayed, pressing **Menu** opens the **MENU of SCREENS**.

C.2.1 Diagnostic Menu

The **DIAGNOSTIC MENU** lists the available diagnostic screens. To display the menu, press **Menu, 5**.

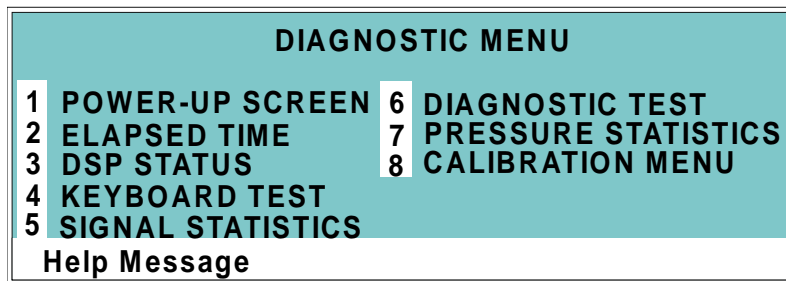

Figure C-11. Diagnostic Menu

There are two ways to select a screen from a menu:

- Press the number button on the keypad that corresponds to the menu option.
- Move the cursor to the field containing the screen number and press **Enter**.

To display a brief description of each screen, press **Help**.

C.2.2 Power-Up Screen

This screen is also displayed when the IC25 is powered up. When the IC25 is connected to the DX-LAN interface, the DX-LAN ID number will be displayed here.

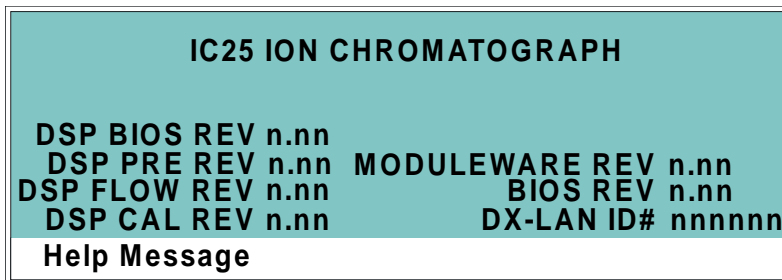

Figure C-12. Power-Up Screen

C.2.3 Elapsed Time

This screen reports for how long various components have been in use. The status is updated in real time.

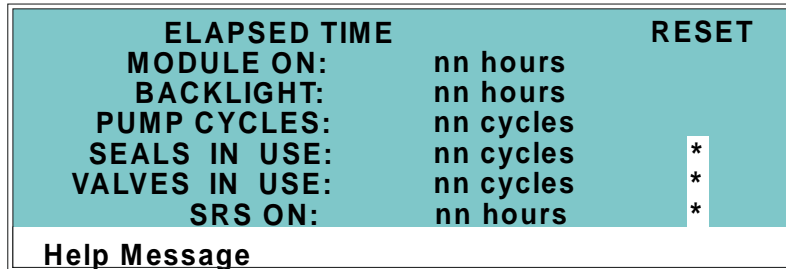

Figure C-13. Elapsed Time Screen

Field	Description
MODULE ON	Reports the total time the IC25 has been powered up in its lifetime.
BACKLIGHT	Reports the total time the display backlight has been on in its lifetime.
PUMP CYCLES	Reports the total cumulative number of pump cycles during the life of the motor. This field is automatically reset to 0 after the pump motor is replaced.
SEALS IN USE	Reports the total number of pump cycles since the last time the seals were replaced. Reset this field to 0 when the seals are replaced.
VALVES IN USE	Reports the total number of pump cycles since the last time the check valves were serviced. Reset this field to 0 when the valves are serviced.
SRS ON	Reports the total time the Self-Regenerating Suppressor has run. Reset this field to zero after replacing the SRS.

C.2.4 DSP Status

This screen reports the status of the DSP (Digital Signal Processor) dynamic parameters. The status is updated in real time.

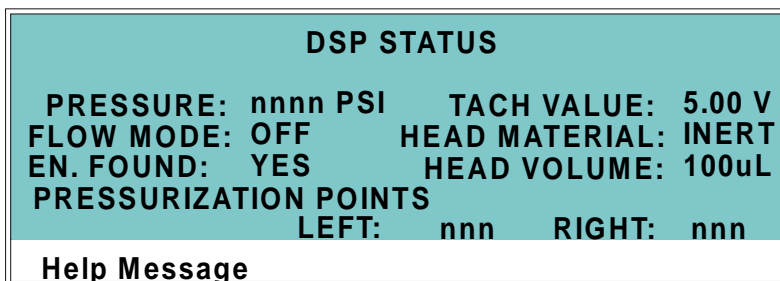

Figure C-14. DSP Status Screen

Field	Description
PRESSURE	Reports the current head pressure in psi, MPa, or bar.
TACH VALUE	Reports the current motor tachometer reading in volts.
FLOW MODE	Reports the flow mode as ON (when the pump is in constant flow mode) or OFF (when the pump is in pressure feedback mode).
HEAD MATERIAL	Reports the head material, INERT (for PEEK heads). This parameter cannot be changed.
EN. FOUND	Reports whether the encoder is found.
HEAD VOLUME	Reports the head volume, 100 μ L. This parameter cannot be changed.
PRESSURIZATION POINTS	Reports the current pressurization point for the left and right pistons. The pressurization points are the points at which the pump speed is adjusted at each stroke to maintain a constant flow rate. When the pump has stabilized, the left and right values are approximately equal (within 5).

C.2.5 Keyboard Test

Use this screen to conduct an interactive test of the front panel keypad buttons.

INJECT	OFFSET	UP	7	8	9	
RUN/HOLD	RESET	LEFT	RIGHT	4	5	6
REMOTE	INSERT	SEL DOWN	SEL UP	1	2	3
OFF/ON	DELETE	HELP	MENU	0	.	E
Help Message						

Figure C-15. Keyboard Test Screen

To test the buttons:

1. Press a button on the IC25 keypad. Its display changes to reverse video, confirming proper operation of the button.
2. Continue pressing each button in turn. Only the most recently pressed button shows in reverse video.
3. To end the test and return to the **DIAGNOSTIC MENU**, press **Menu** twice.

C.2.6 Signal Statistics

This screen lets you monitor the selected input to the A/D circuitry. When the screen is initially displayed, the **MAX** and **MIN** status values are equal to the **INPUT** value and **DURATION** reads 0. Status values are reported in A/D volts and are updated dynamically.

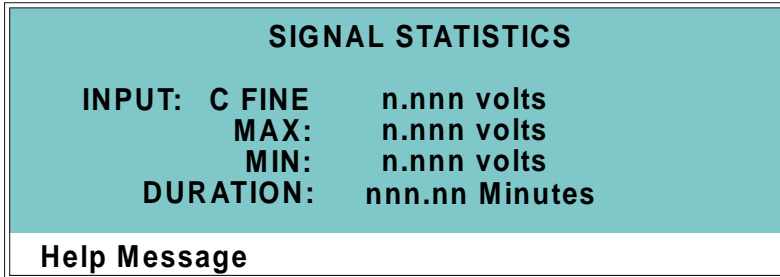

Figure C-16. Signal Statistics Screen

Field	Description
INPUT	The measured data from the A/D circuit: C FINE—Conductivity cell fine input C COARSE—Conductivity cell coarse input C THER—Conductivity cell thermistor input LEAK—Leak detector input DRIVE—Cell drive circuit input
MAX	The maximum input data value during the duration of the test.
MIN	The minimum input data value during the duration of the test.
DURATION	The test duration (in minutes). The test starts when this screen is opened and terminates when the screen is closed.

C.2.7 Diagnostic Test

Use this screen to test the IC25 electronics components. Some of these tests run automatically at power-up; if one of the tests fails, this screen appears, displaying the status of each test.

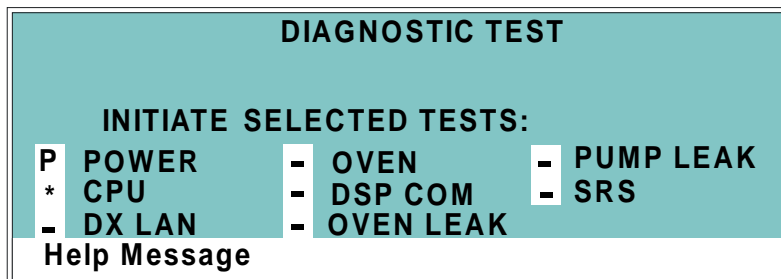

Figure C-17. Diagnostic Test Screen

To run a test, position the cursor in the edit field beside the test name, press a **Select** button to display an asterisk (*), and press **Enter**. When the test is complete, the edit field displays either pass (**P**) or fail (**F**).

Field	Description
POWER	Checks the +5, ±15, and +24 volt monitor on the Relay card.
CPU	Checks the CPU internal configuration and the Moduleware checksum.
DX-LAN	Checks the DX-LAN hardware configuration and loop back.
OVEN	Varies the temperature set point of the LC25 Chromatography Oven and checks the flags.
DSP COM	Checks communication between the CPU and the DSP (Digital Signal Processor) hardware by sending a command and waiting for the appropriate response.
OVEN LEAK	Checks the leak sensor in the LC25 Chromatography Oven for a correct, open circuit, or short circuit condition.
PUMP LEAK	Checks the pump's leak sensor for a correct, open circuit, or short circuit condition.
SRS	Varies the Self-Regenerating Suppressor power supply and checks the flags.

NOTE Exiting the **DIAGNOSTIC TEST** screen clears the pass/fail indicators from the edit fields.

C.2.8 Pressure Statistics

This screen monitors the pressure transducer and reports pressure status values. Status values are updated while the screen is displayed.

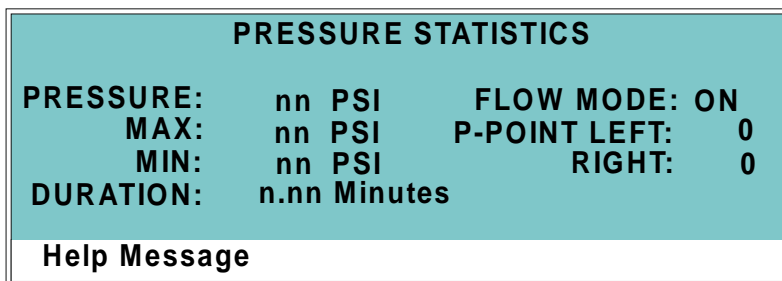

Figure C-18. Pressure Statistics Screen

If a method is running when the **PRESSURE STATISTICS** screen is opened, the following message is displayed:

Active Method Lowers MIN/MAX Resolution

For more accurate readings, abort the method, change to Direct control mode, and then reopen the screen.

Field	Description
PRESSURE	The measured pressure from the pressure transducer.
MAX	The maximum pressure value during the duration of the test.
MIN	The minimum pressure value during the duration of the test.
DURATION	The duration of the test. The test starts upon entering this screen and terminates upon exiting by pressing the Menu button. To restart the test, press Reset ; the duration is set to 0 and all status values are set to the current pressure.
FLOW MODE	Reports the flow mode as ON or OFF . ON = System is in constant flow mode. OFF = System is in pressure feedback mode.
P-POINT LEFT RIGHT	Reports the current pressurization point for the left and right pistons. The readout is updated once per piston stroke.

C.3 Calibration Screens

To go to the **CALIBRATION MENU**, press **Menu, 5, 8**.

C.3.1 Calibration Menu

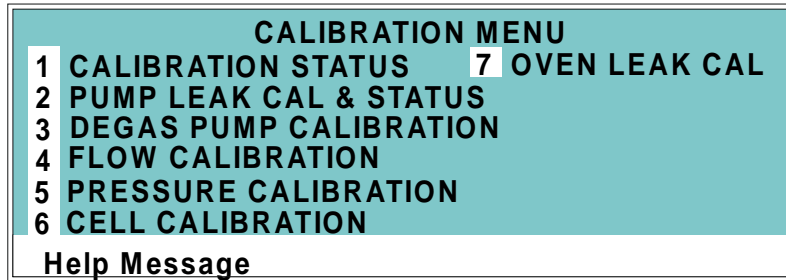

Figure C-19. Calibration Menu Screen

There are two ways to select a screen from a menu:

- Press the number button on the keypad that corresponds to the menu option.
- Move the cursor to the field containing the screen number and press **Enter**.

To display a brief description of each screen, press **Help**.

C.3.2 Calibration Status

This screen reports the status of calibration parameters in real time.

CALIBRATION STATUS	
FLOW RATE CAL:	n.nn g
PRESSURE OFFSET:	nnnn PSI
CAM ENCODER CAL VALUE:	nnn
CELL CALIBRATION CONSTANT:	nnn

Help Message

Figure C-20. Calibration Status Screen

Field	Description
FLOW RATE CAL	The current flow rate calibration value.
PRESSURE OFFSET	The pressure offset calibration value reported by the DSP (Digital Signal Processor).
CAM ENCODER CAL VALUE	The current binary value for cam-encoder calibration reported by the DSP.
CELL CALIBRATION CONSTANT	The calibration constant of the conductivity cell. This is usually the value determined when the cell is calibrated before shipment to the user. Unless the cell is damaged, the calibration constant should not need to be recalibrated.

C.3.3 Leak Sensor Calibration and Status

This screen reports the status of leak sensor parameters. The **PUMP** column displays the status of the pump's internal leak sensor. The **EXTERNAL** column displays the status of the leak sensor in the LC25 Chromatography Oven. If no LC25 is connected to the IC25, the **EXTERNAL** fields display **NONE**.

PUMP LEAK SENSOR CALIBRATION AND STATUS		
	PUMP	EXTERNAL
MEASURED VALUE:	0.00	2.75
CURRENT CONDITION:	DRY	WET
CALIBRATION VALUE:	2.50	2.60
LOW LEAK THRESHOLD:	2.70	2.50
Help Message		

Figure C-21. Leak Sensor Calibration and Status

Field	Description
MEASURED VALUE	The current measured voltage from the sensor, in volts.
CURRENT CONDITION	The current WET , DRY , or ERR (error) condition of the sensor. ERR indicates an open or short circuit. To calibrate a leak sensor, select CAL and press Enter . After calibration, the field reverts to DRY or ERR .
CALIBRATION VALUE	The value saved when the sensor was last calibrated.
LOW LEAK THRESHOLD	The threshold value below which a leak is indicated. The threshold is based on the calibration value.

C.3.4 Degas Pump Calibration

This screen reports the status of the vacuum degas pump calibration parameters in real time, and allows testing of the pump.

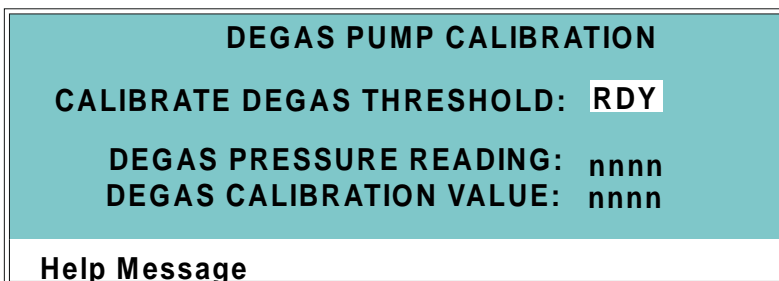

DEGAS PUMP CALIBRATION

CALIBRATE DEGAS THRESHOLD: RDY

DEGAS PRESSURE READING: nnnn

DEGAS CALIBRATION VALUE: nnnn

Help Message

Figure C-22. Degas Pump Calibration Screen

CALIBRATE DEGAS THRESHOLD	To calibrate the degas pump, select CAL and press Enter . When calibration is complete, the entry will revert to RDY .
DEGAS PRESSURE READING	The reading from the degas pump pressure transducer.
DEGAS CALIBRATION VALUE	Reports the calibration value recorded during the last calibration.

C.3.5 Flow Calibration

This screen reports the pump flow rate calibration and provides calibration instructions.

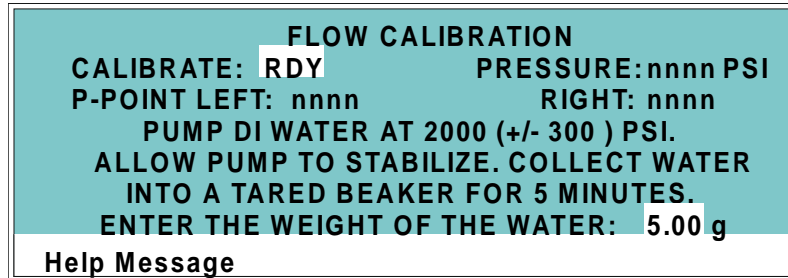

Figure C-23. Flow Calibration Screen

Field	Description
CALIBRATE	To calibrate the flow rate, select CAL to use standard calibration parameters for pump control, or RDY to use stored parameters from the last calibration. After selecting CAL , follow the on-screen calibration instructions. It takes 5 minutes to calibrate standard heads and 20 minutes for microbore heads.
PRESSURE	Displays the measured value from the pressure transducer.
P-POINT LEFT RIGHT	Displays the pressurization points for the left and right pump pistons. When the pump has stabilized, the left and right values should be within 5.
WEIGHT OF THE WATER	After calibration, enter the measured weight of the water pumped into the beaker.

C.3.6 Pressure Calibration

This screen explains how to calibrate the pump pressure and slope.

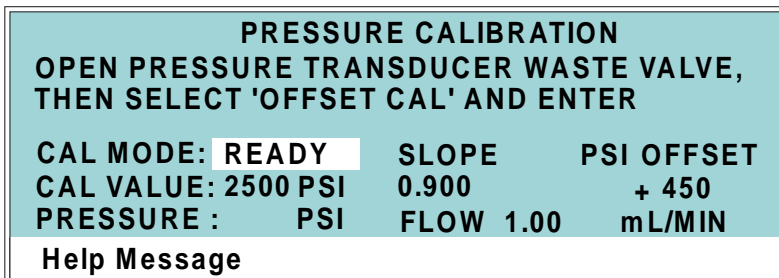

Figure C-24. Pressure Calibration Screen: Initial view

Field	Description
CAL MODE	Selects the calibration mode. READY The pump is ready for calibration. OFFSET CAL Calibrate the offset. SLOPE CAL Calibrate the slope. SLOPE DFLT Use the default slope value. EDIT Enter known correct SLOPE and OFFSET values.
CAL VALUE	Pressure value entered during the slope calibration procedure. Accepted values: 1 to 5000 psi, 1 to 340 bar, 0.1 to 34.0 MPa.
PRESSURE	Current pressure reading from the transducer.
SLOPE	Calibrated slope value. Accepted values: 0.7 to 1.3 (default=0.9).
PSI [MPa] OFFSET	Calibrated offset value. Accepted values: 200 to 1000 psi (default=450) 14 to 68 bar (default=31) 1.4 to 6.8 MPa (default=3.1)
FLOW	Current flow rate.

To calibrate:

1. Stop the pump flow.
2. Go to the **PRESSURE CALIBRATION** screen.
3. Open the pressure transducer waste valve by turning it counterclockwise two turns (see Figure 2-6).
4. When the pressure reaches zero, select **OFFSET CAL** and press **Enter**. The offset calibration begins. When calibration is complete, the screen displays the following:

PRESSURE CALIBRATION			
'ENTER' TO USE SLOPE DEFAULT VALUE, OR SELECT 'SLOPE CAL' TO CONTINUE			
CAL MODE:	SLOPE DFLT	SLOPE	PSI OFFSET
CAL VALUE:	2500 PSI	0.900	+ 450
PRESSURE:	0 PSI	FLOW 1.00	mL/MIN
Help Message			

Figure C-25. Pressure Calibration Screen: Second View

The **PSI OFFSET** field displays the calibrated value. The **SLOPE** field does not change, but the **PRESSURE** field displays the new pressure based on the calibrated offset.

5. There are three choices for continuing the calibration:

Option 1: Save the psi offset and maintain the current slope value.

To finish the offset calibration and keep the current slope value, press **Menu** to exit the **PRESSURE CALIBRATION** screen. The new offset value will be put into effect. No slope calibration is performed.

Option 2: Save the psi offset calibration and save the default slope value.

To continue the calibration with a default slope value, press **Enter**. The **SLOPE** field displays the default slope value. The **PRESSURE** field displays the new pressure based on the calibrated offset and the default slope. The screen then returns to the initial view and calibration is complete.

Option 3: Save the psi offset calibration and calibrate the slope.

To continue to the slope calibration procedure, select **SLOPE CAL** in the **CAL MODE** field and press **Enter**. The screen displays the following:

PRESSURE CALIBRATION			
CLOSE WASTE VALVE, INSTALL GAUGE.			
TURN PUMP ON AND ENTER GAUGE PRESSURE.			
CAL MODE:	SLOPE CAL	SLOPE	PSI OFFSET
CAL VALUE:	2500 PSI	0.900	+ 450
PRESSURE :	PSI	FLOW 1.00	mL/MIN
Help Message			

Figure C-26. Pressure Calibration Screen: Third View

6. Close the waste valve.
7. Install a pressure test gauge between the pressure transducer outlet and either a length of backpressure tubing, or a column (see Figure C-27). A pressure gauge assembly (P/N 046175), including a gauge with an accuracy rating of $\pm 0.25\%$, required fittings, and backpressure tubing, is available for this purpose. Contact Dionex for details.

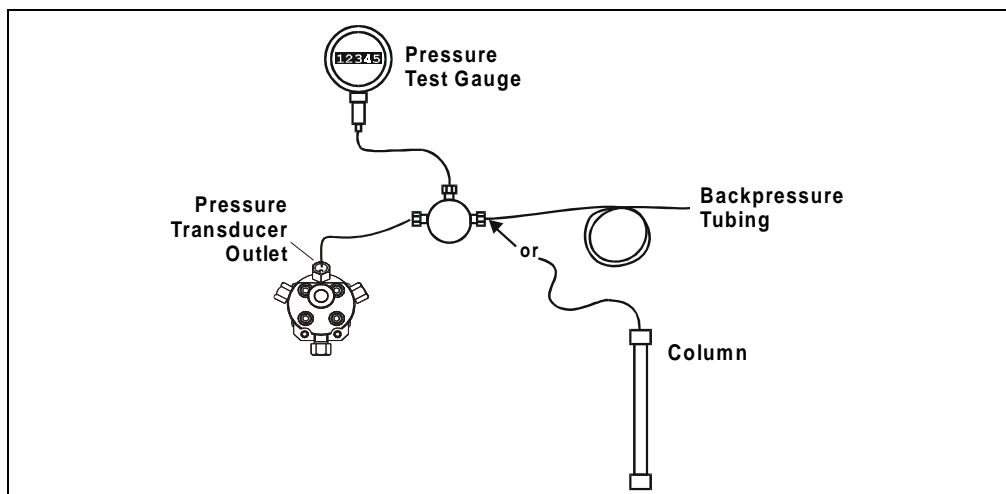

Figure C-27. Pressure Gauge Installation

8. In the **FLOW** field, enter the flow rate normally used for the application.
9. Turn on the pump. The pressure will begin increasing. Allow the pressure gauge reading to stabilize.
10. This step depends on whether backpressure tubing or a column was installed in Step 7.

Backpressure Tubing

If backpressure tubing is installed, the recommended pressure for calibration is 17.25 ± 0.17 MPa (2500 ± 25 psi). If necessary, add backpressure tubing or adjust the flow rate to bring the pressure to the recommended value. Increasing the flow rate increases the pressure; decreasing it decreases the pressure. When the gauge reading stabilizes at the recommended value, enter the reading in the **CAL VALUE** field.

Column

If a column is installed, the application flow rate and the column type determine the pressure for calibration. After allowing the gauge pressure to stabilize, enter the reading in the **CAL VALUE** field.

NOTE The pressure gauge readings may fluctuate slightly as the left and right pump heads alternate piston strokes. You can ignore variations of about ± 0.03 MPa (± 5 psi) or less. Larger fluctuations generally indicate that the pump is out of prime. If this occurs, prime the pump heads (see Section B.5) and then repeat Step 10.

11. Press **Enter**. The slope calibration begins. When calibration is complete, the screen fields display the following:
 - The **SLOPE** field displays the new slope value.
 - The **PRESSURE** field displays the same value as the **CAL VALUE**.

C.3.7 Calibrate Conductivity Cell

This screen is used to calibrate the conductivity cell with 1 mM KCl. See Section 5.8 for detailed instructions.

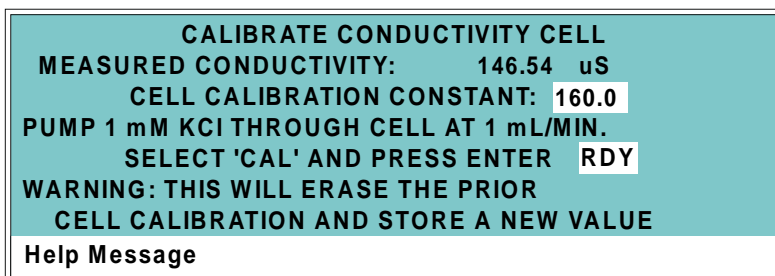

Figure C-28. Calibrate Conductivity Cell Screen

Field	Description
MEASURED CONDUCTIVITY	Reports the measured conductivity from the conductivity cell.
CELL CALIBRATION CONSTANT	Reports the current calibration constant for the cell.
CALIBRATE	Select CAL and press Enter to calibrate the conductivity cell to the value displayed in the conductivity field. The calibration assumes that uncontaminated 1 mM KCl is flowing through the cell at normal backpressure. The new value replaces the previous calibration value.

D • TTL and Relay Control

The strip of eight 2-pin connectors in the IC25 electronics chassis provides two relay outputs, two TTL outputs, and four TTL inputs (see Figure D-1).

- Connect the outputs to the TTL or relay inputs of a Dionex (or non-Dionex) device to control functions of the connected device. Be sure the devices are compatible with the IC25 TTL and relay signals.
- Connect the inputs to a Dionex (or non-Dionex) device to control any four of these IC25 functions: pump/SRS on/off, method clock on/off, offset, method number increment, method number decrement, mark, and range x10. All other functions must be controlled from the IC25 front panel.

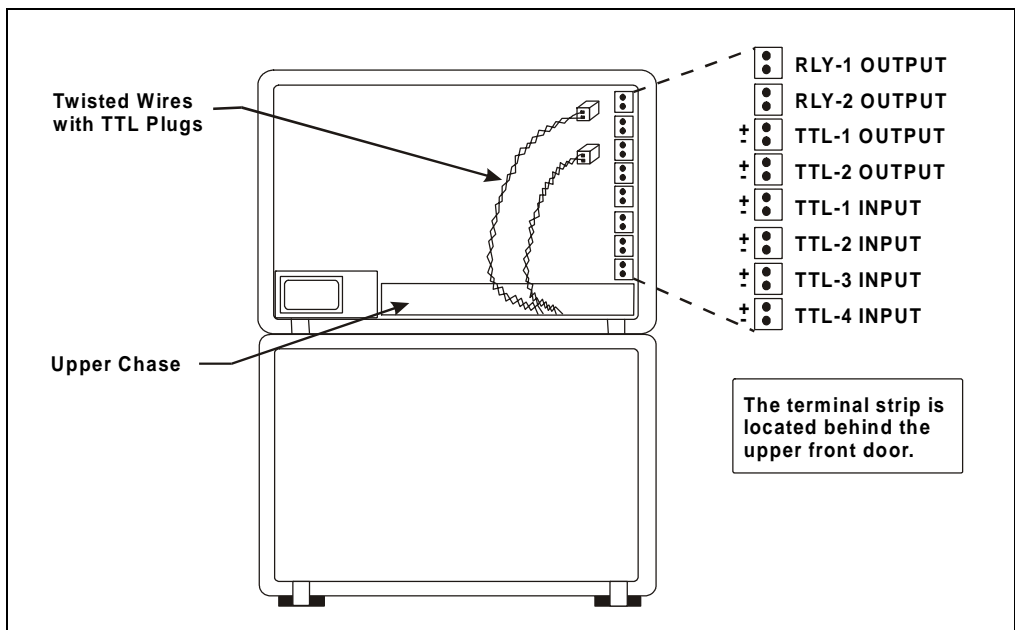

Figure D-1. TTL Connector Strip
(IC25 Front View without Upper Door)

D.1 TTL and Relay Output Operation

The IC25 provides two TTL outputs and two relay contacts to control functions in external devices such as an integrator or autosampler.

After connecting the TTL and Relay outputs (see Section D.3), toggle the output states on and off from the **DETAIL** screen (see Figure D-2) or from the **METHOD** screen (see Figure C-5 in Appendix C). Use the **DETAIL** screen to directly control the outputs and use the **METHOD** screen for timed operation of the outputs.

- To turn on a TTL or relay output, set the corresponding output field on the **MAIN** screen or **METHOD** screen to **1** (closed).
- To turn off a TTL or relay output, set the corresponding output field to **0** (open).

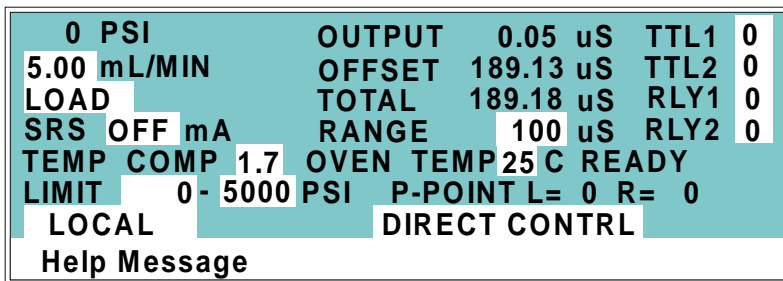

Figure D-2. Detail Screen

D.2 TTL Input Operation

The four TTL inputs can be connected to devices capable of providing TTL input signals. The signals from the connected devices can control any four of the seven functions listed below:

- **PUMP/SRS ON/OFF**
Turns the pump motor and the SRS on and off.
- **RUN METHOD**
Turns the method clock on and off. Turning off the method clock resets it to zero and executes **INIT** conditions. The method will not run unless the pump motor is already on.
- **OFFSET**
Stores the offset value. The baseline is set by subtracting this measured offset value from all subsequent measurements.
- **METHOD NUMBER INCRement**
Increases the method number by one. Each additional signal increases the method number by one more. When the method clock is zero (or **INIT**), increasing the method number executes the **INIT** conditions of the new method. When the method clock is greater than zero, increasing the method number begins running the new method at the current elapsed method clock time. This has the same result as selecting a new method number when the IC25 is in Local mode.
- **METHOD NUMBER DECRement**
Decreases the method number by one. The operation is as described under method number increment above, except that method numbers decrease instead of increase.
- **MARK**
Sends a positive pulse to the analog output (recorder) as an event marker.
- **RANGE x10**
Increases the analog output range 10 times.

D.2.1 Input Function Assignments

Assign functions to the TTL inputs from the **TIME FUNCTION IN** screen. Figure D-3 shows the default assignments. Use the **Select** buttons to change assignments.

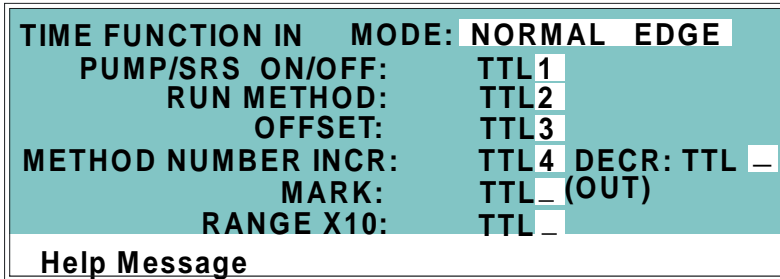

Figure D-3. Time Function In Screen

D.2.2 TTL Input Signal Modes

The TTL inputs respond to four types of signals to accommodate different types of device output signals. The default signal mode, *normal edge*, is compatible with the output signals provided by Dionex modules. If the device connected to the IC25 outputs a different signal type, select the appropriate signal mode from the **TIME FUNCTION IN** screen (see Figure D-3).

The four input signal modes are:

- *Normal Edge*: In normal edge operation, the negative (falling) edge of a signal turns on the function and the positive (rising) edge turns off the function (see Figure D-4). For example, a negative edge sent to TTL1 turns on the pump motor and a positive edge turns off the motor.
- *Inverted Edge*: The inverted edge mode works identically to the normal edge mode except that the positive and negative edges are reversed in function.
- *Normal Pulse*: In normal pulse operation, the negative (falling) edge of the TTL signal is the active edge and the positive (rising) edge is ignored. For example, applying a negative pulse to TTL1 when the pump motor is off turns the motor on. This has the same result as pressing the **Off/On** button on the front panel keypad.

The minimum pulse width guaranteed to be detected is 50 ms. The maximum pulse width guaranteed to be ignored as noise or invalid is 4 ms. The action of the IC25 is undefined for pulses less than 50 ms or greater than 4 ms.

- *Inverted Pulse*: The inverted pulse mode operates identically to the normal pulse mode, except that the positive and negative edges are reversed in function.

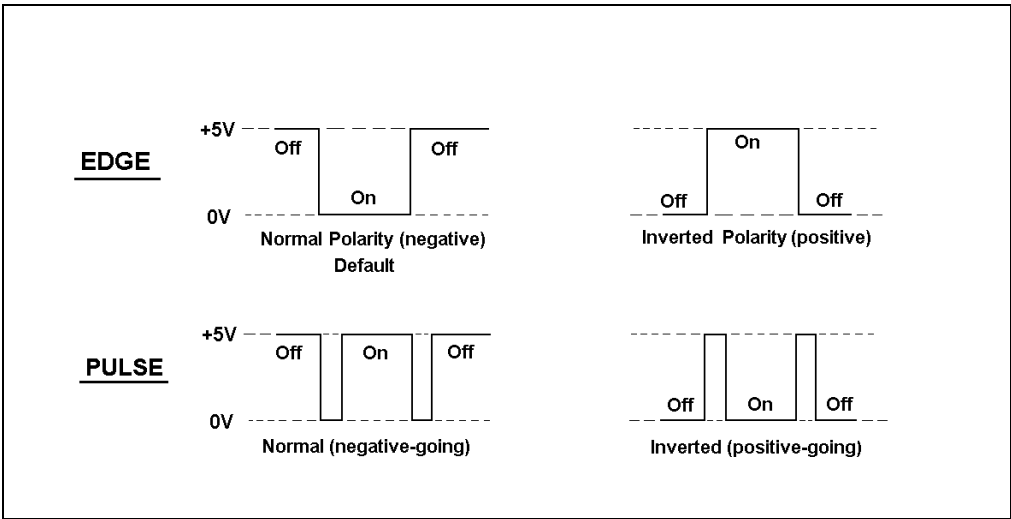

Figure D-4. TTL and Relay Input Signal Modes

D.3 TTL and Relay Connections

The TTL/relay connector strip is located on the electronics chassis behind the upper door of the IC25 (see Figure D-1). Each 2-pin connector includes a signal pin and a ground pin.

1. Twisted pairs of wires (P/N 043598) and 2-pin connector plugs (P/N 921019) are provided in the IC25 Ship Kit. Attach a 2-pin plug to each end of the twisted pair of wires to be connected. The signal wire (red) goes on top and the ground wire (black) goes on the bottom of each plug.
2. Connect these plugs to the TTL or relay connectors on the IC25 and the other module(s) as needed for the application. Check the polarity of each connection. Connect signal wires to signal (+) pins and ground wires to ground (-) pins. If necessary, remove wires from the two-pin plugs and reinsert them in the correct positions. Section D.3.1 shows example connections.
3. Route the wires from the IC25 electronics chassis through the upper chase to the rear panel.

D.3.1 Example Connections

Figure D-5 shows an example of TTL/relay connections for an IC25 connected to an AS40 Automated Sampler. Refer to the AS40 operator's manual for more information.

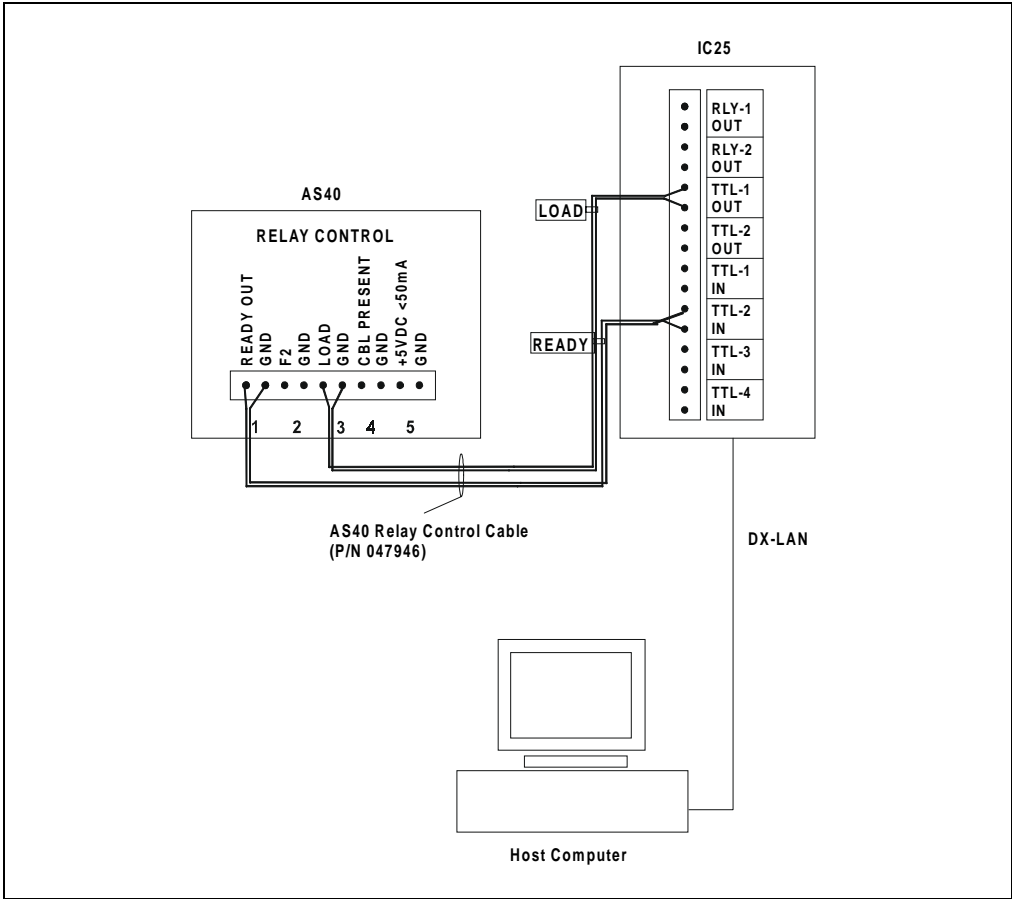

Figure D-5. Example TTL and Relay Connections: AS40

IC25 Ion Chromatograph

Figure D-6 and Figure D-7 show two different TTL/relay connections for an IC25 connected to an AS3500 Autosampler:

- Setup 1 starts running the IC25 timed events method when the autosampler makes an injection.
- Setup 2 starts running the Dionex module method before the autosampler makes an injection. The method then controls when the autosampler injection occurs.

Refer to the *PeakNet AS3500 Autosampler User's Guide* for details.

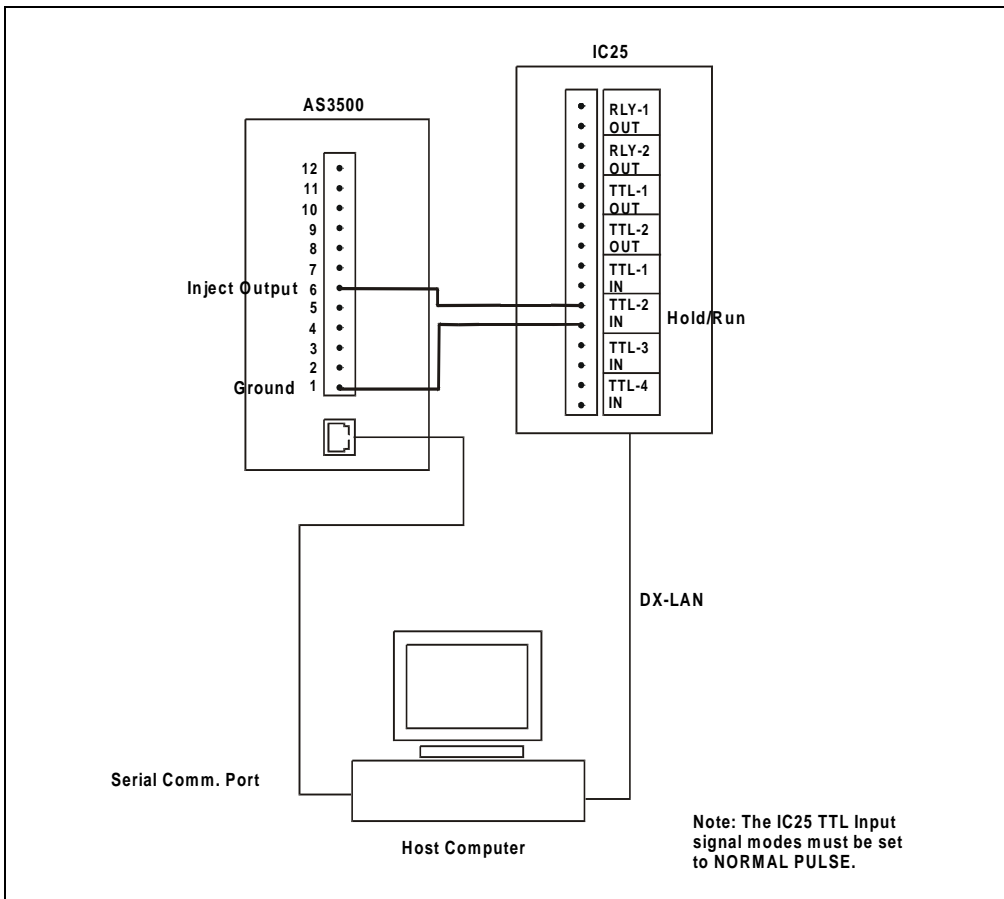

Figure D-6. Example TTL and Relay Connections: AS3500 Setup 1

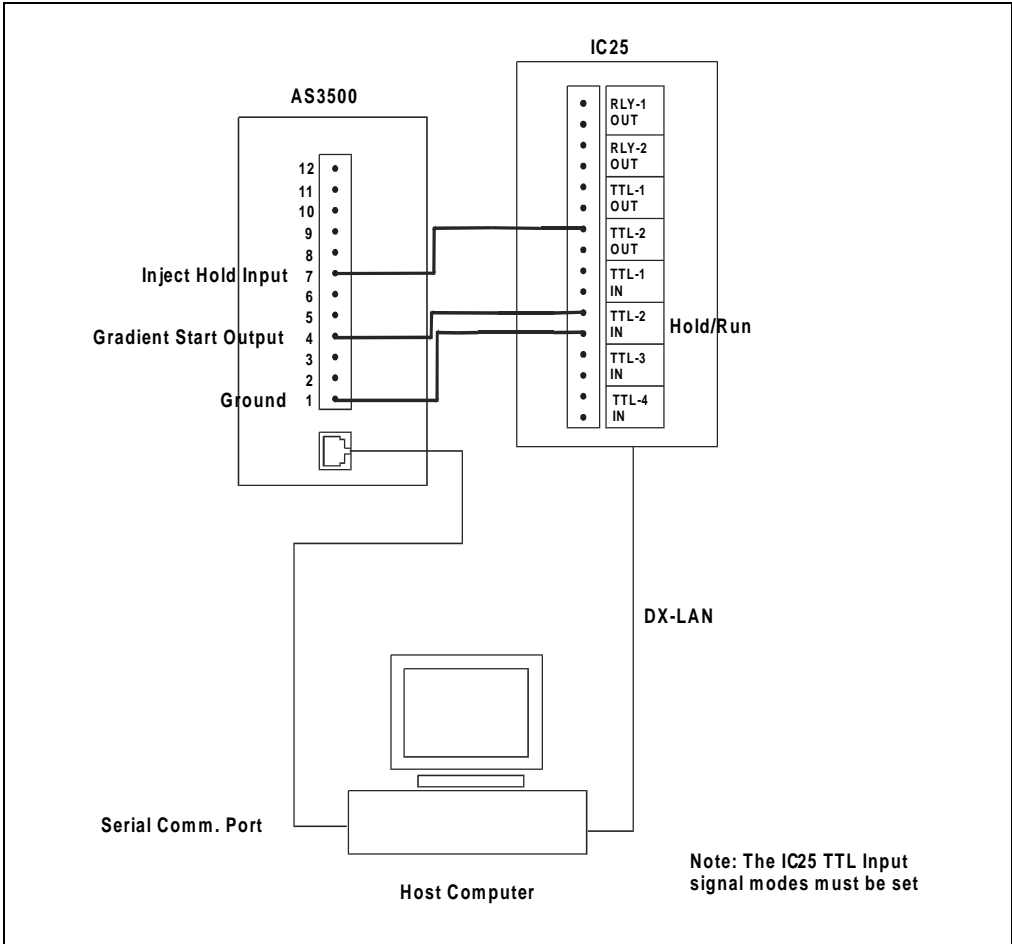

Figure D-7. Example TTL and Relay Connections:
AS3500 Setup 2

E • Reordering Information

Part Number	Item	Quantity
051601	Standard IC25	1
051999	IC25 with Single-Chamber Vacuum Degas Pump	1
051905	IC25 with Double-Chamber Vacuum Degas Pump and Eluent Selection Valve	1
044125	E01 Eluent Organizers	1
044126	1-Liter Glass Reservoir with Shatterproof Plastic Coating	1
044127	2-Liter Glass Reservoir with Shatterproof Plastic Coating	1
044128	1-Liter Plastic Reservoir	1
044129	2-Liter Plastic Reservoir	1
045987	End-Line Filters	1
047694	Eluent Line "A"	1
047695	Eluent Line "B"	1
051997	Regulator (gas supply line)	1
054578	10 mL Syringe	1
054418	Rinse Waste Tubes	1
054086	Pump Priming Block Assembly	1
047747	Pump Check Valve Cartridge	1
042772	10-32 Fitting Plug	1
037628	1/4-28 Fitting Plug	1
046434	Pressure Transducer Waste Valve O-Ring	1
046175	Pressure Gauge Assembly	
043276	Ferrule Fittings	1
043275	10-32 Fitting Bolts	1
042690	0.25-mm (0.010-in) ID Tubing (for cell outlet backpressure)	1

IC25 Ion Chromatograph

Part Number	Item	Quantity
042627	Union (for connecting backpressure tubing to waste line)	1
046440	Power Supply	1
045369	DSP Card	1
046340	CPU Card	1
043598	Twisted Black and Red Wires (for recorder/diagnostic and TTL/Relay connections)	1
921019	Green TTL Connector Plugs	1
954745	3.15 Amp Fuse (Fast-Blow IEC127, type 1)	2

Numerics

10BASE-T cable installation, B-5
10BASE-T DX-LAN interface installation,
B-4–B-6
60-pin ribbon cable, 2-9

A

Aborting a running method, 3-11
Activating button press sounds, C-9
Activating error sounds, C-9
Actuator for main power switch, 2-1
Air pressure requirements, 3-2
Analog output
 Offset level, C-14
AS40 Automated Sampler, D-7

B

Backlight, C-9
Backpressure limits, 5-11
Baseline
 Oscillations, 2-13
Blank screen, C-1
BNC DX-LAN interface installation, B-7–B-9
BNC tee connector installation, B-8
Button press sound, C-9

C

Cables
 10BASE-T DX-LAN, B-4–B-5
 60-pin ribbon, 2-9
 Coaxial DX-LAN, B-7–B-8
Calibration, 2-13
Calibration Menu, C-23

See Also Diagnostic screens
Calibration Status, C-24
Degas Pump Calibration, C-32
Degas Status, C-26
Flow Calibration, C-27
Leak Sensor Calibration and Status, C-25
Pressure Calibration, C-28
Calibration screens, C-23
Calibration Status screen, C-24
Cascading hubs, B-6
Cell
 See Conductivity cell
Check valve
 Cleaning, 5-3
Circuit boards, 2-6
 CPU, 2-9
 DX-LAN, 2-9
 Relay I/O, 2-9
Circuitry, A/D, C-20
Clock
 See Method clock
Coaxial DX-LAN cable installation, B-8
Column switching valve
 Selecting, C-4
Conductivity cell, 2-13
 Air bubble removal, 5-11
 Backpressure limits, 5-11
 Benefits, 2-13
 Calibration, 2-13, C-32
 Calibration constant, 5-12
 Calibration procedure, 5-12
 Specifications, A-2
Conductivity detection
 Temperature variations, 2-13
Connectors
 DX-LAN, B-2
 Electronics chassis, 2-6
 LC Air valves, 2-7

- LC Leak, 2-7
- TTL/Relay control, 2-7
- Contrast, 2-1
- Control modes
 - Method, 2-17
- Control panel, 2-1
 - Keypad, 2-2
- Conventions, 1-3
- CPU circuit board, 2-9
- Creating a method, 3-7

D

- Daily maintenance, 3-12
- Degas Options screen, C-12
- Degas Pump Calibration screen, C-32
- Degas Status screen, C-26
- Degas vacuum pump, 2-14
- Deleting a method, 3-11
- Description
 - Calibration screens, C-23
 - Diagnostic screens, C-15
 - Functional, 2-16
 - Modes of operation, 2-17
 - Operational screens, C-3
 - TTL input control, D-3
- Detector interface card
 - Installation procedure, B-4–B-5, B-7–B-8
- Detector specifications, A-2
- Diagnostic menu, C-15
- Diagnostic screens, C-15
 - See Also* Calibration Menu
 - Degas Status, C-26
 - Diagnostic menu, C-15
 - Diagnostic Test, C-21
 - DSP Code Version, C-23
 - Elapsed Time, C-17
 - Keyboard Test, C-19
 - Leak Status, C-25
 - Power-Up screen, C-16
 - Pressure Calibration, C-28
- Diagnostic Test screen, C-21
- Digital Signal Processor (DSP), 1-1

- Direct control mode, 3-4
 - Relay assignments, C-6
 - TTL assignments, C-5
- Display and keypad specifications, A-3
- Display screens, 2-5
 - Backlight, C-9
 - Calibration Status, C-24
 - Degas Options, C-12
 - Degas Pump Calibration, C-32
 - Degas Status, C-26
 - Diagnostic menu, C-15
 - Diagnostic screens, C-15, C-23
 - Diagnostic Test, C-21
 - DSP Code Version, C-23
 - Elapsed Time, C-17
 - Leak Status, C-25
 - Main status, C-3
 - Menu of Screens, C-2
 - Method edit, C-7
 - Module Setup screen, C-9
 - Power-Up, 2-5, 3-3, C-16
 - Pressure Calibration, C-28
 - Time Function In, C-11
- DSP card
 - Troubleshooting, 4-8
- DX-LAN
 - 10BASE-T cable installation, B-5
 - Card, 2-9
 - Coaxial cable installation, B-8–B-9
 - Connector, B-2
 - Remote control, 2-17
- DX-LAN 10BASE-T interface
 - Installation, B-4–B-6
- DX-LAN BNC interface
 - Installation, B-7–B-9
- DX-LAN network
 - Problems, 4-15

E

- E01 Eluent Organizers, 2-15, E-1
- Edge input signal mode, D-4
- Editing a method, 3-10

- Elapsed Time screen, C-17
- Electrical specifications, A-1
- Electronics
 - Testing, C-20
- Electronics chassis, 2-6
 - Connections, B-7
 - CPU, 2-9
 - TTL/Relay connections, D-6
 - TTL/Relay connectors, 2-7
- Eluent
 - Conductivity suppression, 2-13
 - Connecting lines to pump, B-11
 - Outlet line connections, B-11
 - Priming the lines, B-12
- Eluent Flow Schematic, 2-11
- Eluent selection valve, 1-1, 2-17, E-1
- End-line filter, 3-2
- Entry error sounds, C-9
- Environmental specifications, A-1
- Error messages
 - Degas vacuum pump not present, 4-10
 - DSP ..., 4-6
 - Encoder index not found, 4-6
 - High pressure limit violation, 4-5
 - Low pressure limit violation, 4-4, C-13
 - Low Vacuum Alarm, 4-11
 - Motor drive fails, 4-6
 - TTL2 is set to indicate Flow/No Flow, 4-11
 - Vacuum degas fails, 4-10
- F**
- Facilities required, B-1
- Ferrule fittings, 4-13, 5-11
- Filter, end-line, 3-2
- Flow Calibration screen, C-27
- Flow column, on Method screen, 3-6
- Flow rate
 - Ranges, 2-10
 - Stabilizing, 3-6
- Front panel, 2-1
 - Display screens, 2-5
 - Keypad, 2-2
- Functional description, 2-16
 - Method control, 2-17
 - Modes of operation, 2-17
 - TTL input, D-3
- Fuses, A-1
 - Replacing, 5-2
- G**
- Generating a method, 3-7
- H**
- Hub, 10BASE-T, B-4–B-7, B-9
- Humidity, operating, A-1
- Hydraulic specifications, A-2
- I**
- IC25
 - Versions, 1-1
- Initial conditions, 2-3
- Injection valve, 2-7
 - Controlling position of, C-3
- Installation, B-1
 - CPU, 2-9
 - Detector interface card, B-4–B-5, B-7–B-8
 - DX-LAN, B-4
 - Eluent line connections to pump, B-11
 - Eluent outlet line, B-11
 - Eluent reservoirs, 2-15
 - Facilities required, B-1
 - LC25 communication, B-10
 - Power connection, B-2
 - Priming the eluent inlet lines, B-12
 - Rear panel, 2-15
 - Setting pressure limits, 3-4
 - TTL/Relay connections, D-6
 - Waste line, B-3
- Interior components, 2-10
- Inverted edge, D-4
- Inverted pulse, D-5

K

- Keyboard Test screen, C-19
- Keypad buttons, 2-2
 - Button press sound, C-9

L

- LC25 Chromatography Oven, 2-7, 2-13
 - Set point, 2-8
 - Temperature range, 1-1
 - Temperature selection, C-3
 - Temperature selection guidelines, 3-3
- Leak alarm, 4-6
- Leak sensor calibration, C-25
- Leak status screen, C-25
- Leaks, liquid, 5-11
- Left/right pressurization points, C-22
- Limit field
 - Method screen, C-8
 - Selecting pressure limits, 3-4
- Liquid crystal display (LCD)
 - Adjusting the screen contrast, 2-1
- Liquid leaks, 4-6
- Liquid lines, 5-3
- Local mode, 2-17, C-4
 - Selecting
- Locked Remote mode, 2-17

M

- Main status screen, C-3
- Maintenance
 - Daily, 3-12
 - Periodic, 3-14
 - Replacing piston seals, 3-14
 - Routine maintenance, 3-12
- Mechanical chassis, 2-10
- Menu of Screens, C-2
- Menu structure chart, C-1
- Method clock, 2-18
 - Controlling, 3-9
 - Holding (pausing), 2-3

Resetting, 2-3

Starting a method, 3-9

Method control, 3-6

Method edit screen, C-7

Method steps

Definition, 2-18

Deleting, 3-10

Entering, 3-6, C-7

Inserting, 3-8

Maximum number allowed, 2-18

Methods

Aborting a running method, 3-11

Control, 3-6

Creating, 3-7

Deleting a method, 3-11

Deleting a step, 3-10

Editing, 3-10

Number allowed, 2-18

Running a method, 3-9

Modes of operation

See Local mode

See Operating modes

See Remote mode

Module Setup screen, C-9

Moduleware, 2-9

N

Normal edge, D-4

Normal pulse, D-4

O

Offset calibration, C-28

Operating configuration

TTL input, D-3

Operating modes

Direct control, 3-4

Local mode, 2-17

Locked Remote mode, 2-17, C-4

Method control, 2-17

Remote mode, 2-17

Operation, 3-1
 Aborting a running method, 3-11
 Creating a method, 3-7
 Deleting a method, 3-11
 Editing a method, 3-10
 INIT conditions, 3-7
 Method control, 3-6
 Preparing to run, 3-1
 Running a method, 3-9
 Selecting pressure limits, 3-4
 Shutdown, 3-12
Operational screens, C-3

P

Pausing the method clock, 2-3
PEEK liquid lines, 5-3
Periodic maintenance, 3-14
Physical description
 Control panel, 2-2
 Display screens, 2-5
 Layout, 2-1
 Pressure transducer, 2-12
 Pump priming block, 2-12
 Rear panel, 2-15
 Vacuum degas assembly, 2-14
Physical specifications, A-1
Piston replacement, 5-9
Piston seal replacement, 5-5
Piston volume, 2-10
Power
 Requirements, A-1
Power supply, 2-9
Power switches, 2-1
Power-Up screen, 2-5, 3-3, C-16
Pressure Calibration screen, C-28
Pressure limits, 3-4, C-8
Pressure transducer, 2-12
 Assembly drawing, 5-9
 Waste valve, B-14
Pressure, operating, 2-10
Pressurization points, C-22
Priming

 Eluent lines, B-12
 Pump out of prime, 4-1
Priming block, 2-12
Pulse input signal mode, D-4
Pump heads
 Assembly drawing, 5-5
Pump priming block, 2-12

R

Rear panel, 2-15
 BNC tee connector installation, B-8
 DX-LAN 10BASE-T cable installation,
 B-5
 DX-LAN coaxial cable installation, B-8
Recorders
 Analog output setting, C-14
Regulator, gas supply, 3-2
Relay connectors, 2-7
 See Also TTL/Relay control, 2-7
Relay control
 Turning on/off, C-6
Relief valve, B-14
Remote mode, 2-17, C-4
 Selecting
Rinsing the pump heads, 3-12
Rise time, C-14
Routine maintenance, 3-12
Running a method, 3-9

S

Safety messages, 1-3
Save To field
 Method screen, C-7
Screen brightness, C-9
Screen contrast, 2-1
Screens
 See Display screens
Seal replacement, 5-5
Self-Regenerating Suppressor (SRS), B-16
 Automatic shut off, B-16

Power supply specifications, A-3

Service

- Check valves, 5-3
- Fuses, 5-2
- Piston seal, 5-5
- Pump piston, 5-9
- Waste valve O-ring, 5-10

Service procedures

- Conductivity cell calibration, 5-12
- Removing air from the conductivity cell, 5-11

Setting pressure limits, 3-4

Shutdown, 3-12

Signal modes for TTL input, D-4

Specifications

- Display and keypad, A-3
- Electrical, A-1
- Environmental, A-1
- Hydraulic, A-2
- Physical, A-1
- Vacuum degas assembly, A-3

SRS, B-16

- See* Self-Regenerating Suppressor (SRS)

Stabilization time for flow rates, 3-6

System outlet line, B-11

T

Temperature

- Minimizing the effect of variations, 2-13

Temperature compensation, 2-13

- Optimizing, 3-11

Temperature compensation factor

- Selection, C-5

Temperature, operating, A-1, A-3

Tests

- Diagnostic, C-21
- Keyboard, C-19
- Pressure transducer, C-22
- Vacuum degas pump, C-26

Time

- Pump, seals, backlight in use, C-17
- Setting the clock, 3-9

Time Function In screen, C-11, D-4

Time-based steps, entering, 3-6

Transducer, 2-12

Troubleshooting, 4-1

- Cell constant reading inaccurate, 4-14
- Chromatographic reproducibility, 4-12
- Degas vacuum pump calibration, 4-10
- DX-LAN communication, 4-15
- High detector output, 4-13
- Leak alarm, 4-6
- Liquid leaks, 4-6
- Low detector output, 4-13
- No detector response, 4-12
- Noisy baseline, 4-13
- Noisy pump motor, 4-8
- Pump head pressure fluctuations, 4-1
- Pump out of prime, 4-1
- Pump stops, 4-3
- Pump will not start, 4-3
- Relay control functions, 4-11

TTL/Relay control, D-1

- Connectors, D-1
- Example connections, D-7
- Input operation, D-3
- Input signal modes, D-4
- Installation, D-6
- Output operation, D-1
- Turning on/off, C-5

TTL/Relay control connections, 2-7

TTL2 output usage, B-16

TUV, 1-4

Type of control, 2-17

- Method control, 2-17

U

User interface screens

- See* Display screens

V

V (valve) column on Method screen, 3-6, C-8

Vacuum degas assembly, 1-1, 2-14, E-1

 Specifications, A-3

Valves

 Check valves, 5-3

 Column switching, C-4

 Injection, C-3

Voltage, full-scale, C-14

W

Waste line installation, B-3

Waste valve, B-14

